

MIDWAY

NOVEMBER 1997
16-44044-101

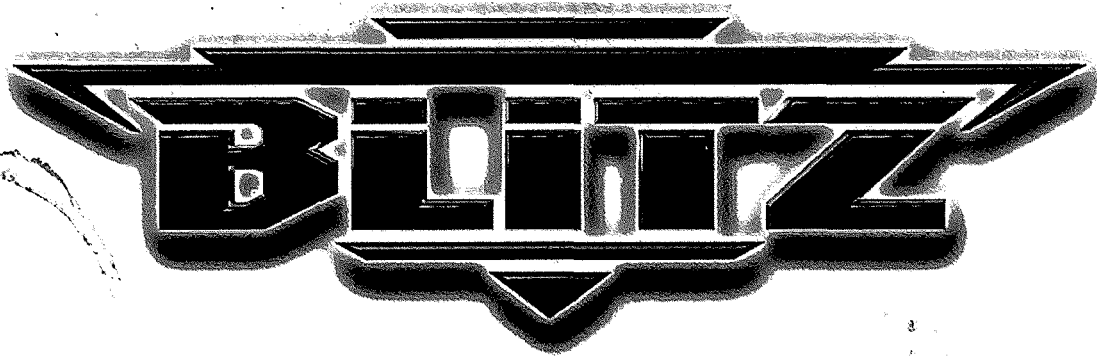

TM

VIDEO GAME CONVERSION KIT

Operations Manual Includes

- Kit Installation & Operation
- Testing & Problem Diagnosis
 - Parts Information
 - Wiring Diagrams

Midway Games Inc.
3401 North California Avenue
Chicago, Illinois 60618



100-100-100



100-100-100



TABLE OF CONTENTS

Section One - Installation

Safety Notices	1-2
Product Specifications.....	1-3
FCC Compliance.....	1-3
Epilepsy Warning.....	1-3
Inspection.....	1-4
Recommended Tools and Supplies.....	1-5
Converting a Typical Video Game Cabinet.....	1-6
Cabinet Modifications.....	1-6
Control Panel Modifications.....	1-7
Game Electronics Installation.....	1-9
Cabinet Wiring.....	1-11
Initial Power Up.....	1-12
Control Panel Template Player 1.....	1-13
Control Panel Template Player 2.....	1-15

Section Two - Operation

Game Operation	2-2
Starting Up.....	2-2
Game Rules.....	2-2
Player Controls.....	2-3
Operator Controls.....	2-4
Menu System Operation	2-5
System Overview.....	2-5
Screen Layout.....	2-5
Organization.....	2-5
Diagnostics	2-6
Monitor Setup.....	2-7
System Information.....	2-8
Real Time Clock.....	2-8
Sound Subsystem Test.....	2-9
Disk Tests.....	2-10
Switch Tests.....	2-11
DIP-Switch Test.....	2-12
Audits	2-13
Coin Audits.....	2-14

Credits Audits.....	2-14
Game Audits.....	2-15
Clear Audits.....	2-16
Adjustments.....	2-17
Pricing.....	2-17
Current Pricing.....	2-18
Additional Adjustments.....	2-19
Volume Level.....	2-20
Standard Pricing Table.....	2-21
Switches and Jumpers.....	2-22

Section Three - Cabinet Wiring

JAMMA Chart.....	3-2
Recommended Cabinet Wiring Diagram.....	3-3
Control Wiring Diagram.....	3-4
CPU Board Indicator and Switch Locations.....	3-5
CPU Board Jumper Status Chart.....	3-6
CPU Switches.....	3-7
CPU Board LED Indicator Status Chart.....	3-7

Section Four - Troubleshooting

Game Does Not Start.....	4-2
Game Can Not Be Played.....	4-3
Coin Switch and Meter Wiring.....	4-4
Player Control Problems.....	4-5
Audio Problems.....	4-6
Video Problems.....	4-7
Miscellaneous.....	4-8

BLITZ KIT

SECTION ONE

INSTALLATION

Warning

USE OF NON-MIDWAY PARTS OR CIRCUIT MODIFICATIONS MAY CAUSE SERIOUS INJURY OR EQUIPMENT DAMAGE! USE ONLY MIDWAY AUTHORIZED PARTS.

* For safety and reliability, substitute parts and modifications are not recommended.

* Substitute parts or modifications may void FCC type acceptance.

SAFETY NOTICES

The following safety instructions apply to all operators and service personnel. Specific warnings and cautions will be found throughout this manual where they apply. We recommend that you read this page before preparing your game for play.



CAUTION

HANDLING ELECTRONIC DEVICES: This kit uses complex electronic components that are SENSITIVE to static electricity. The following precautions must be observed and followed prior to handling any of the electronics that make up this game.

- 1) Ensure that the A.C. power to the game is turned off prior to servicing the electronics.
- 2) Discharge any static electricity build up in your body by touching the safety ground stud of the power supply chassis. This must be done BEFORE touching or handling the electronic assemblies.
- 3) Store the electronic assemblies in an anti-static area. Anti-static bags must be used to store the CPU board assembly. Use the same bag to save the old CPU assembly after the new unit is installed.
- 4) DO NOT remove or connect any electronic assemblies when the cabinet power is on. Doing so will damage the electronic assemblies and void the warranty.

DISCONNECT POWER DURING INSTALLATION OR REPAIRS. Always turn your game OFF and unplug it before attempting to service or install your kit. Installing or repairing PC boards with power ON can damage components and void the warranty. Be sure that all ground wires are installed securely.

PROPERLY GROUND THE GAME. To avoid electrical shocks, do not plug in the game until it has been inspected and properly grounded. This game should only be plugged into a grounded 3-wire outlet. Do not use a "cheater" plug or cut off the ground pin on the line cord.

USE PROPER FUSE. To avoid electrical shock, all replacement fuses must match the original fuse in fuse type, voltage rating, and current rating.

SALVAGED PARTS. Parts salvaged from old games are required to complete your kit. These salvaged parts must operate perfectly; otherwise, the converted game cannot perform properly or safely. Always repair circuit board malfunctions and cabinet damage before conversion is attempted.

POWER SUPPLY. Be sure the power supply from your old game is capable of +5Vdc at 5A, -5Vdc at 1A, and +12Vdc at 2A. Measure these operating voltages while existing electronics are installed in the game. All power supply voltages should be $\pm 5\%$ under load. Your power supply must be FCC approved.

WIRING. This kit uses as much of the existing wiring as possible. To avoid errors in operation, verify that the wiring is an exact match with the diagrams after conversion is completed but before applying power.

MONITOR. This kit is not intended for use with X-Y monitors. Suitable monitors have horizontally mounted CRTs and raster electronics with inputs for RGB video and COMPOSITE NEGATIVE SYNC.

COIN MECHANISMS. Be sure to clean and test your game coin mechanisms with known currency. Servicing of these mechanisms is crucial to your game's earning potential and operation.

COIN METERS. Coin meters are not provided with this kit. Wiring information is provided as a convenience to the operator. Existing meters may be used provided their operation is verified.

HANDLE FLUORESCENT TUBE AND CRT WITH CARE. If you drop a fluorescent tube or a CRT and it breaks, it will implode! Shattered glass can fly eight feet or more from the implosion.

HARD DISK DRIVE. The hard disk drive must be packed in an anti-static bag. The disk drive assembly must be removed from the tray and packed in an approved shipping container (P/N 08-8068) in order to be sent in for repair or replacement. Do not stack or drop hard disk drives during installation or removal.

PRODUCT SPECIFICATIONS

Game Characteristics

Player Variables

1 or 2 players per game
High Score Recognition

Operator Variables

Coinage, Play Mode,
Difficulty, Volume,
Audits, Statistics

Diagnostics

Automatic Power-Up Self-Test
Manual Multi-Level Menu System

Equipment Characteristics

Video Display Monitor

Low or Medium Resolution RGB
with Composite Negative Sync

Audio System

Digital Stereo sound
for 2 Coaxial Full
Range Speakers

Currency Acceptors

4 Coin Switch Inputs
1 Dollar Bill Validator Input

NOTICE - FCC COMPLIANCE

**INSTALLATION OF THIS KIT INTO ANY EXISTING PRODUCT DOES NOT
GUARANTEE COMPLIANCE WITH FCC REQUIREMENTS. YOU ARE SOLELY
RESPONSIBLE FOR FCC COMPLIANCE FOR INSTALLATIONS IN OTHER
PRODUCTS. ANY EXISTING FCC COMPLIANCE LABEL MUST BE REMOVED
AND A NEW LABEL SHOULD NOT BE INSTALLED ON THE CONVERTED
PRODUCT UNTIL YOU HAVE VERIFIED FCC COMPLIANCE.**

EPILEPSY WARNING

A very small portion of the population has a condition which may cause them to experience epileptic seizures or have momentary loss of consciousness when viewing certain kinds of flashing lights or patterns that are present in our daily environment. These persons may experience seizures while watching some kinds of television pictures or playing certain video games. People who have not had any previous seizures may nonetheless have an undetected epileptic condition.

If you or anyone in your family has experienced symptoms linked to an epileptic condition (e.g. seizures or loss of awareness), immediately consult your physician before using any video games.

We recommend that parents observe their children while they play video games. If you or your child experience the following symptoms: dizziness, altered vision, eye or muscle twitching, involuntary movements, loss of awareness, disorientation, or convulsions, **DISCONTINUE USE IMMEDIATELY** and consult your physician.

ATTENTION

PROPERLY ATTACH ALL CONNECTORS. Be sure that the connectors on each printed circuit board (PCB) are properly connected. If they do not slip on easily, do not force them. A reversed connector may damage your game and void the warranty. All connectors are keyed to fit specific pins on each board.

INSPECTION

Unpack the materials from the carton and inspect for obvious signs of damage. Use this checklist to be sure the kit is complete. You must supply the remainder of the materials required for this conversion.

Part Number	Item	Quantity	
[] A-21055	Fan Assembly	1	(cools game electronics and disk drive)
[] A-21891-1	Blitz CPU Board Assembly	1	(microprocessor and game electronics)
[] A-21939-1	Blitz 49-way Joystick Assembly	2	(deluxe player motion controls)
[] A-22062	Blitz Hard Disk Drive Assembly	1	(game program and graphic images)
[] H-22079-1	49-way Joystick Cable Assembly 1	1	(to connect player controls to electronics)
[] H-22079-2	49-way Joystick Cable Assembly 2	1	(to connect player controls to electronics)
[] RM-37-11	Flexible Grommet .155" x .2" x 7"	1	(protects wires at edges of metal cover)
[] 01-14568.1	Blitz Perforated Electronics Cover	1	(limits CPU radio frequency interference)
[] 03-7947	Cable Tie 8 inch length	1	(to secure wiring inside game cabinet)
[] 03-9664	Control Panel Cover	1	(to protect control panel surface)
[] 04-10861	Electronics Metal Mounting Plate	1	(mounts game electronics and disk drive)
[] 08-8068	Hard Disk Drive Shipping Container	1	(to protect hard disk drive during transit)
[] 11-1274	Wood Spacer for Joystick	1	(used to mount joysticks on thin panels)
[] 16-8587-825	FBI Warning Label	1	(federal game protection warning)
[] 16-9478.2	Registration Card	1	(official recording of game ownership)
[] 16-9922.1	Epilepsy Warning Label	1	(alerts players to epilepsy possibility)
[] 16-10077	Electronic Device Caution Sheet	1	(suggestions to avoid damaging parts)
[] 16-10139	FCC / Canada Warning Label	1	(suggestions to avoid interference)
[] 16-10363	Program Copyright Label	1	(legal rights of product and its uses)
[] 16-10443	Control Panel Template	1	(to mark new Player Control hole layout)
[] 16-44044-101	Blitz Video Conversion Kit Manual	1	(installation, operation, troubleshooting)
[] 20-9620	T-20 Tamper Resist Wrench	1	(to mount Control Panel Overlay)
[] 20-9727	Cable Tie Clamp - Self-adhesive	1	(to mount cables)
[] 20-10209-1	Red Long Shaft Pushbutton	2	(player controls for character activity)
[] 20-10209-2	White Long Shaft Pushbutton	2	(player controls for character activity)
[] 20-10209-3	Blue Long Shaft Pushbutton	2	(player controls for character activity)
[] 20-10209-5	Yellow Long Shaft Pushbutton	2	(player controls for character activity)
[] 20-10383	Hard Disk Drive Power Cable	1	(connects disk drive to game power)
[] 31-2863.1-3	Blitz Marquee Artwork	1	(identifies game cabinet to players)
[] 31-2864	Blitz Top Bezel Decal	1	(passing and special game play rules)
[] 31-2865	Blitz Bottom Bezel Decal	1	(offensive and defensive combinations)
[] 31-2868.1	Cabinet Decal	1	(to cover existing cabinet markings)
[] 31-2869	Cabinet Side Panel Decal	2	(to cover existing cabinet markings)
[] 31-2870	Control Panel Wallpaper Decal	1	(to cover existing panel markings)
[] 31-2871	Control Panel Markings Decal	1	(to identify Player Controls)
[] 4006-01209-04	6-32 x .25" Philips pan-head screw	4	(to attach disk drive to mounting bracket)
[] 4008-01035-06	8-32 x .375" Philips pan-head screw	10	(to attach CPU Board to mounting plate)
[] 4106-01115-08	#6 x .50" HWH sheet metal screw	26	(to attach electronic parts to cabinet)
[] 4108-01193-10B	Tamper resistant sheet metal screw	10	(to attach clear overlay to control panel)
[] 4308-01123-24B	8-32 x 1.5" Carriage bolt	8	(to attach joysticks to control panel)
[] 4408-01128-00	8-32 Keps nut	8	(to attach joysticks to control panel)
[] 5556-13956-00	2 Piece 1.25" Square Ferrite Beads	4	(controls radio frequency interference)
[] 5795-15286-00	Hard Disk Drive Data Cable	1	(connects disk drive to game electronics)

Recommended tools and supplies

- [] black semi-gloss paint
- [] electric drill and wood drill bit set
- [] screwdrivers
- [] liquid soap (dishwashing detergent)
- [] grease pencil or marker
- [] nut drivers or socket wrench set
- [] 180 grit sandpaper or electric sander
- [] wood filler material (putty, glue, board, etc.)
- [] black electrical tape
- [] small screw assortment
- [] razor knife
- [] squeegee or soft sponge
- [] soldering iron and solder
- [] wire cutters
- [] pliers
- [] hole saw or equivalent

NOTES:

1. CONTROL PANEL FITS IN BETWEEN WOOD SPACER AND COVER SLIDE
2. DO NOT USE WOOD SPACER FOR PANELS THICKER THAN .5 IN. (13MM)
3. SEAT "E" RING FULLY IN RING GROOVE OF SHAFT DURING REASSEMBLY

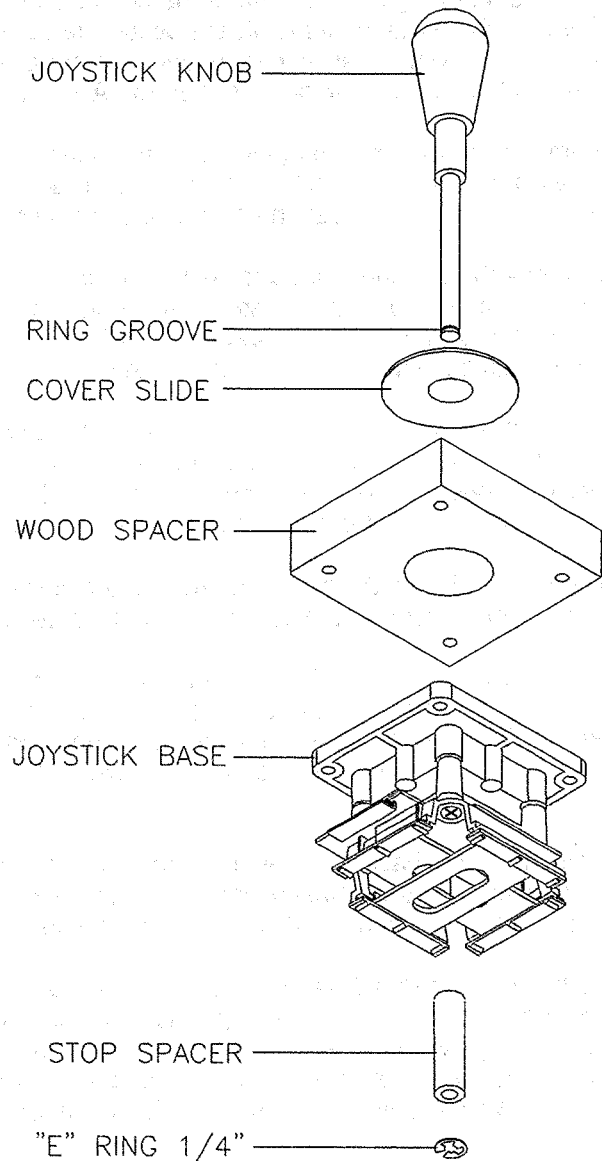

49-WAY JOYSTICK ASSEMBLY

CONVERTING A TYPICAL VIDEO GAME CABINET

CABINET MODIFICATIONS

1. Verify the operation of the existing game before making any changes to the cabinet. Pay special attention to those components that will be used again after conversion is completed (Power Supply, Video Monitor, Currency Acceptors, Wiring Harnesses, Cabinet Locks, Lighted Marquee, etc.).
2. Switch off power to the game. Disconnect the line cord from the A.C. power. Clear the work area. Cover or protect the non-wood items (marquee, monitor, coin door, brackets, line cord, etc.).
3. For cabinets with wood grain sides, remove the old decals and any artwork. Clean off all glue residue. Fill gouges, unused holes, etc with quick-hardening wood putty. Sand smooth and remove all dust.
4. Evenly cover the entire cabinet with black paint. Allow the paint to dry completely before continuing.
5. Pencil a line roughly at the top of the previous graphic. Lightly moisten the cabinet with soapy water. Remove the backing and apply the decal. Start at the top and work down. After the decal is in place, smooth it outwards, taking care to squeeze out air bubbles. If you can not remove an air bubble, pop it with a knife or pin and smooth it down. Allow at least 12 hours for the adhesive in the decal to set.
6. Remove the existing marquee from the game cabinet and install the new kit marquee in its place. Check the lamp and install a new one if cracks or darkened ends are found, even if it still lights at the time of inspection. Clean the marquee glass before reinstalling it in the game.
7. Remove the viewing glass and set it in a safe place. Clean the CRT and the bezel. Apply the player moves and the game play instruction decals to the top and bottom front of the monitor bezel. Place the Epilepsy Warning label and the AAMA rating on the top front of the monitor bezel. Be sure that the decals and labels do not obstruct the viewing area. Clean the viewing glass before reinstalling it.
8. If this kit is installed in a MIDWAY universal video cabinet (model 40135), the FCC compliance label (16-10139) supplied is to be placed on the rear of the cabinet. *Installation of this kit into any other product does not guarantee compliance with FCC requirements. The FCC compliance label supplied should not be installed on the converted product until FCC compliance is verified.*
9. Remove and save the screws at the top and sides of the rear door. Unlock the rear door, then lift it off of the cabinet and set it aside. Use a vacuum cleaner to remove any dirt or debris inside the cabinet.
10. Locate the control panel latches or fasteners and free the control panel from its normal position. If there is no wiring harness connector, label each of the wires before disconnecting them from the Player Controls. Once the wires are disconnected, remove the control panel from the game cabinet. Save the mounting brackets and hardware for reinstallation after the control panel has been modified.
11. Some cabinets have speakers located on the control panel or other removable pieces of the cabinet. If speaker harnesses must be disconnected, be certain to mark the polarity of the wires as well as the function. Incorrectly phased speakers can cause weak low frequencies or a thin, hollow sound quality.
12. *Optional:* Standard 8-way joysticks may be used with this kit if desired (49-way joysticks and cables are provided in the kit). These joysticks will use the standard JAMMA connections. The CPU Board has an adjustment to accept 8-way joystick control signals. However, the game will not have the same fine control of character motion and speed when using the standard joysticks. We recommend that the 49-way joysticks be installed for maximum player enjoyment.

CONTROL PANEL MODIFICATIONS

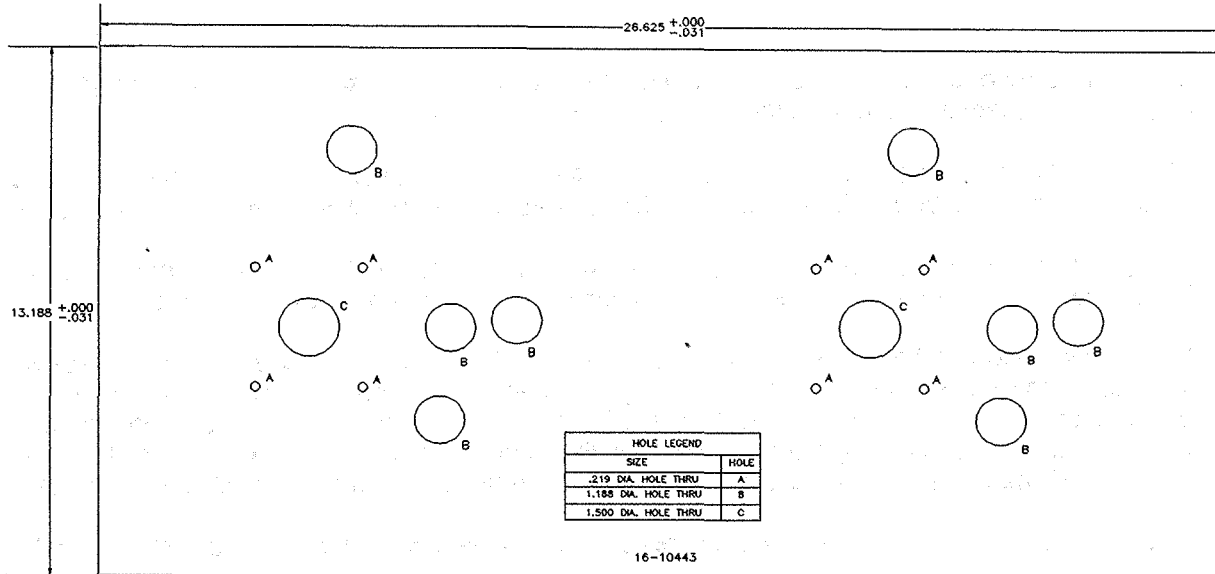

CONTROL PANEL TEMPLATE

1. Locate the control panel template (16-10443) and unfold it. Stack newspapers, books, magazines, etc., on the template until needed. This will flatten it sufficiently for use. A full size copy of the hole pattern for one set of player controls is included as the last page in this section of the manual.
2. Remove the control panel buttons and joysticks from the existing control panel. Remove the panel covering and any artwork from the previous game. Remove any hinges or mounting brackets.
3. Fill the existing control panel holes with wood, putty, glue or other suitable material. Allow adequate time for materials to dry, then sand or file the control panel to a flat surface on both sides.
4. Place the template on top of the repaired panel. Orient it to center the controls and tape it in place. Cut new holes for the joysticks and the control panel buttons. Remove template and deburr all holes.
5. Remove the backing and apply the decal to the panel. Start at the top and work down. After the decal is in place, smooth it outwards, taking care to squeeze out air bubbles. If you can not remove an air bubble, pop it with a knife or pin and smooth it down. Allow the adhesive in the decal to set.

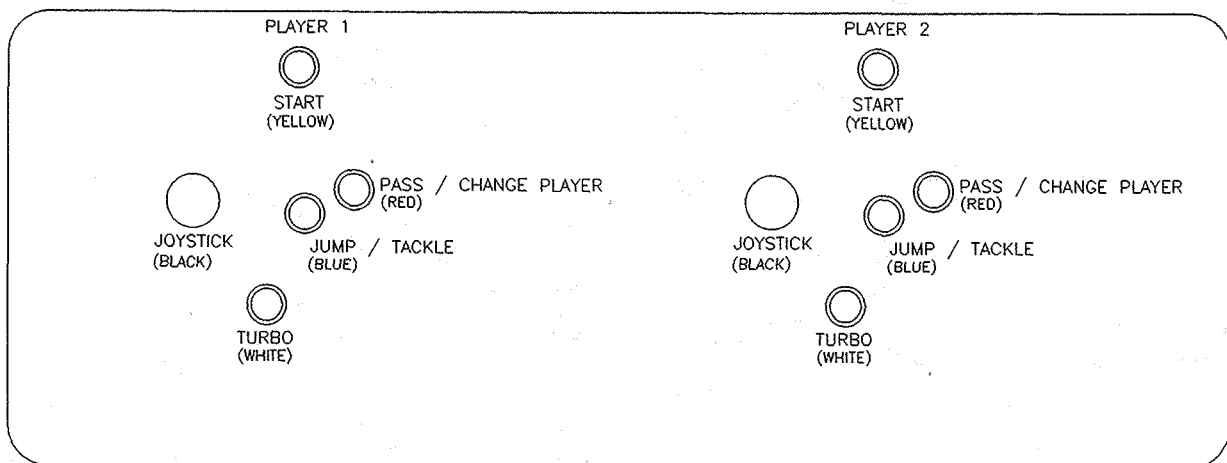

CONTROL LOCATIONS

6. Use a sharp knife to trim the edges and to cut the holes for the control panel buttons and joysticks. Position the control decals next to the appropriate hole locations.
7. Place the plastic cover over the decals and panel. Mark the outside shape of the panel and the hole locations. Cut and deburr all holes, then trim the cover to shape. Mount with tamper resistant screws.
8. Group the Player Controls by color: Start - yellow, Pass / Change Player - red, Jump / Tackle - blue, Turbo - white, Joysticks - black. The controls must be disassembled for panel mounting.
9. Separate each switch from its push-button. Gently bend the large prong away from the microswitch just enough to slide the switch off of the housing. Unscrew the nut from the housing. Insert the push-button housing through the switch hole from the front side of the control panel. Screw the nut finger tight onto the switch housing from the back of the panel. Rotate the housing so that the switch terminals will be properly oriented and tighten the nuts firmly. Snap the switch back onto the housing.
10. Repeat this step for each button of a different color. Continue until all button groups are mounted.
11. Measure the thickness of the control panel. If it is less than ½ inch (13 mm), use the wooden spacers to recess the joysticks below the surface. Thicker control panels do not require the wooden spacers.
12. Install a carriage bolt in each of the small holes surrounding the opening for the joysticks. If required, place each wood spacer over the carriage bolts to correct the joystick mounting depth.
13. Disassemble a joystick for mounting. Invert the joystick and remove the "E"-ring from the shaft. Remove the handle and the plastic ring (large washer) from the joystick base. *Be sure that the bushings remain in the base.* Place the top of the joystick base against the bottom of the control panel (or spacer, if used) and align the mounting holes. Attach the base to the underside of the control panel. Slide the plastic ring around the shaft so that the rough side is next to the shaft knob handle. Slide the shaft through the control panel and base. Replace the "E"-ring.
14. Repeat this step for each of the other joysticks. Continue until all joysticks are mounted.
15. The completed control panel should now resemble the illustration below. Install the modified control panel onto the modified cabinet using the existing mounting hardware.

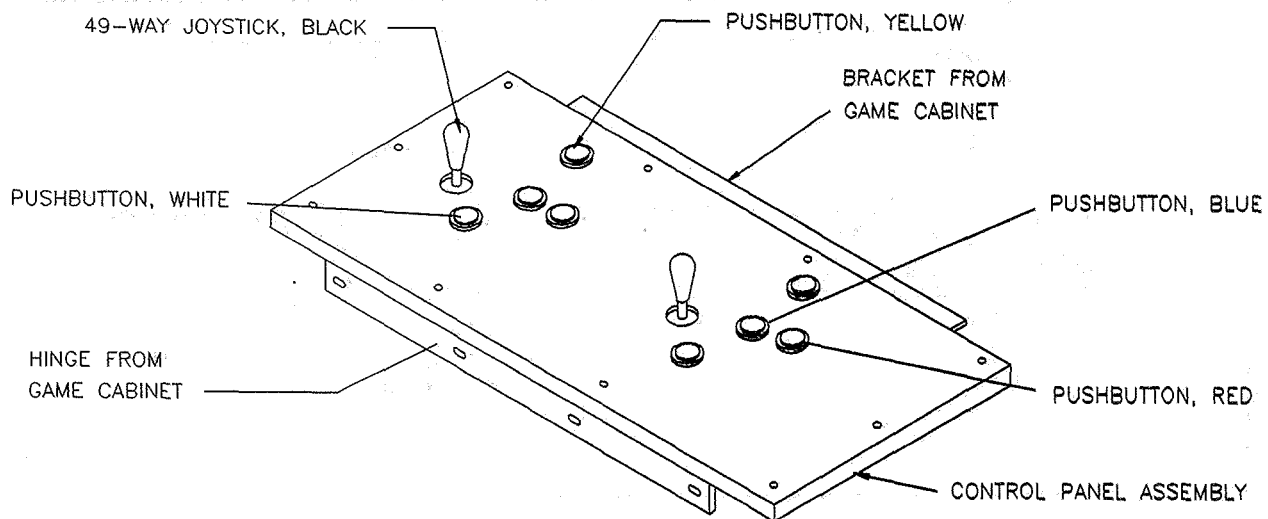

TYPICAL COMPLETED CONTROL PANEL

GAME ELECTRONICS INSTALLATION

The CPU Board Assembly electronic components are static sensitive. Prepare an anti-static work area and ground yourself before removing the CPU Board from its protective shipping materials.

Do not connect any cable to the CPU Board Assembly or Power Supply with the power turned on. Doing so while the power is turned on may damage the game and void your warranty.

CAUTION: HARD DISK DRIVES ARE FRAGILE. Do not stack or drop Hard Disk Drive Assemblies.

1. Be certain that the power is switched off and the cord is disconnected from the A.C. line voltage. Carefully disconnect the cables on each printed circuit board in the game. Remove the existing printed circuit board set and the disk drive (if present) and set aside. Anti-static bags and protective containers from the new components may be used to store these items after conversion is complete.
2. Remove the CPU Board Mounting Plate Assembly from its packaging and place it on a flat work surface. Unpack the CPU Board Assembly and place it over the Mounting Plate Assembly. Align the CPU Board mounting holes with the posts and attach using the 8-32 Philips pan-head screws.
3. Change DIP Switches *if 8-way joysticks, low resolution monitors, or other options are used with this kit.* Charts listing these switch settings are found under DIP-Switch Test in Section Two (Operation).
4. Locate the Hard Disk Drive Power Cable (separate wires with four-pin plastic connectors at each end). Attach the power cable to CPU connector HDPOWER (near the large heatsink). Mate the connectors and press firmly to seat the contacts fully. *The connector is keyed. Do not use excessive force.*
5. Locate the Hard Disk Drive Data Cable Assembly (flat ribbon cable with a rectangular ferrite bead). Orient the connector over CPU Board P25 with the striped edge next to Pin 1 (nearest the micro-processor). Mate the connectors and press firmly to seat the contacts fully. *This connector is keyed.*
6. Remove the Hard Disk Drive Assembly from its package. Locate the data and power connectors on the Hard Disk Drive. Orient the Disk Drive with connectors toward the CPU Board and place it into the mounting brackets on the tray. Align screw holes and install the 6-32 screws with spring washers.
7. Connect the remaining end of the Hard Disk Drive Power Cable to the connector on the disk drive. Mate the connectors and press firmly to seat the contacts fully. *Do not use excessive force.*
8. Locate the free end of the Hard Disk Drive Data Cable (flat ribbon with stripe on one side). This cable is already attached to the CPU Board Hard Disk Drive Connector. Orient this cable with the striped edge closest to the power cable. Attach the cable to the drive data connector. Mate the connectors and press firmly to seat the contacts fully. *This connector is keyed. Do not use excessive force.*
9. The Fan Assembly installs on the mounting plate beneath the CPU Board and beside the Hard Disk Drive. Orient the fan so that it will blow up across the CPU Board (look for fan markings to indicate air flow direction). Align the fan mounting holes with the holes in the plate and install sheet metal screws.
10. Place the game electronics in the cabinet where the previous electronics were located. The new game electronics assembly may be attached directly to the cabinet wall or first mounted on a separate piece of wood. Orient the assembly so that the long edges are vertical and the larger heatsinks are at the top. Use the plate itself as a template to mark mounting hole locations.
11. If necessary, drill pilot holes for mounting screws. Use sheet metal screws to secure the CPU board to the cabinet. Attach the plate with only four corner screws at this time. *Do not use excessive force*

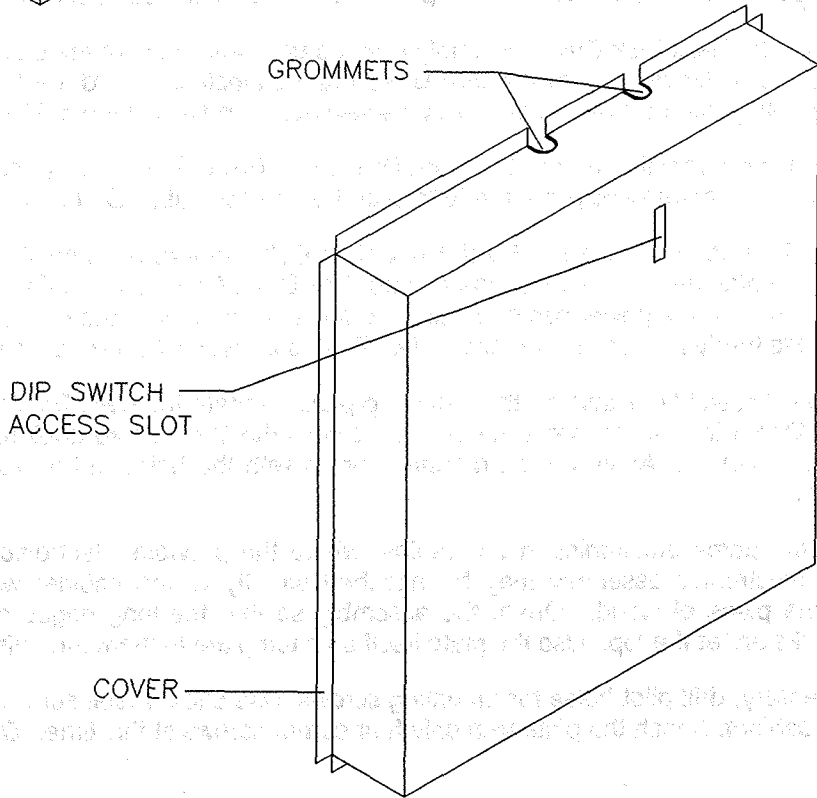
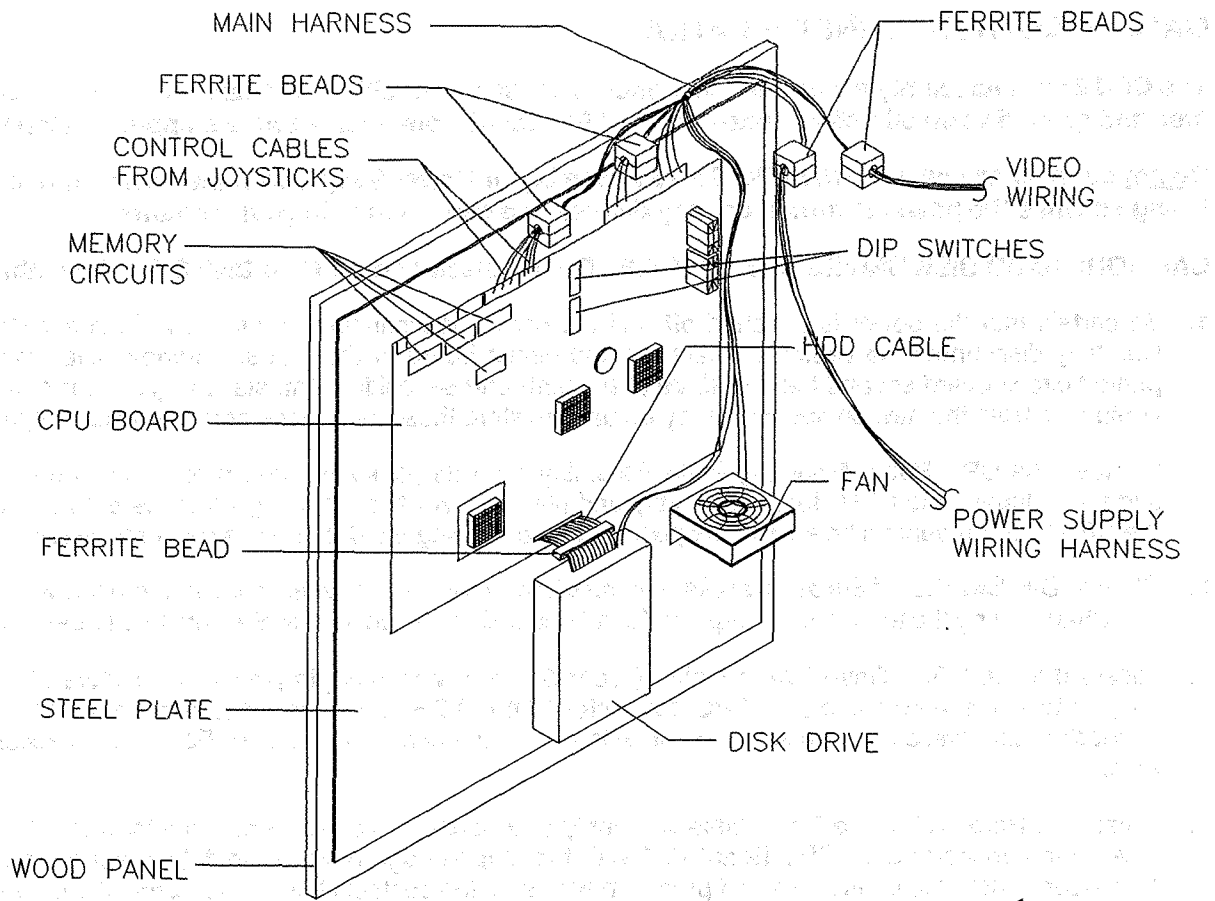

ELECTRONIC COMPONENTS ORIENTATION

CABINET WIRING

NOTE: The operator must install a JAMMA wiring harness, or use the original JAMMA cable from the game. Inspect existing cabinet wiring and compare with the Recommended Wiring Diagram (Section Three). Most games already have JAMMA wiring compatible with the conversion kit. Optional 8-way joysticks also use wires in the JAMMA cable. If the connectors in your cabinet do not fit onto the CPU Board or wire colors do not match the JAMMA Chart, contact your authorized distributor for assistance.



CAUTION

Properly insulate any unused wires within the JAMMA cable, especially red, yellow, orange and black power wires. Secure any unused connectors away from the CPU Board and its cover.

1. Connect the JAMMA cable to the CPU Board Assembly. This cable has wires for the control buttons, 8-way joysticks (if used), the speakers, the coin door, the video monitor, and the power supply. Using the Cabinet Wiring Diagram as a reference, connect the wires to the control panel pushbuttons. Player 1 has white-'color stripe' wires, except Start button 1 which has a solid white wire. Player 2 has violet-'color stripe' wires. Insulate and secure all unused wires. Verify continuity of each JAMMA wire.
2. *Skip this step if the new 49-way Joysticks are not used* (store the cables together with the joysticks). Connect a new Control Panel/49-way Joystick cable between CPU Board P9 and the Player 1 joystick. This cable has solid blue or blue-'color stripe' wires. Connect the other Control Panel/49-way Joystick cable between CPU Board P10 and the joystick for Player 2. This cable has gray-'color stripe' wires. Using the Cabinet Wiring Diagram as a reference, connect the wires to the control panel. Route both cables along side of the existing wiring harness. Secure the wiring with a cable clamp and cable ties.
3. If your cabinet does not have service switches in the coin door area, you may wish to add them at this time (this speeds up routine service calls). Most new game electronics can accommodate signals for service credits, test modes, and volume changes. Wire colors, connector pin assignments, and sample wiring diagrams for these momentary switches are found in Section Three of this manual.
4. Connect the fan to a source of 12 volt D.C. power (refer to the Wiring Diagram in Section Three). Be certain that the polarity is correct so that the air flow from the fan will be in the expected direction.
5. Locate the square split ferrite beads. Separate the wires in the main harness into two bundles where they attach to the JAMMA connector. Install one ferrite bead around the D.C. power conductors (solid color heavy gauge wires with pin numbers 1-6 or A-F). Install another bead around the control panel conductors (striped color lighter gauge wires). Install the remaining ferrite beads on the video monitor cable and power supply wires as shown. Place the beads as close to the JAMMA connector as possible, then close and lock each one. Ensure that no wires are pinched or caught in the latches.
6. Electrical codes require conductive assemblies to be grounded for safe product operation. Locate the central power ground point for the cabinet (ground wires are usually green; some may have a yellow stripe). Connect a short, heavy gauge ground wire from the plate to the central power ground. Reconnect any ground wires loosened or removed in previous steps (control panel, coin door, etc.).

FINAL ASSEMBLY

1. Place the FBI Warning Label next to the CPU board. Be sure the label is completely visible.
2. Locate the Flexible Grommet strip supplied with the kit. Use pieces of this material to line the cable entry cutout areas in the Perforated Metal Cover. This avoids damage to the cabinet wiring harness.
3. Orient the Perforated Metal Cover over the game electronics with its grommets up and hold it in place. Mark the locations of the openings on the side of the cabinet to permit proper routing of the cables in the next set of installation steps. Do not install the cover at this time.
4. If necessary, drill pilot holes for cover screws. Guide wiring through grommets and place the metal cover over the electronics. Align holes and secure the cover to the plate with the sheet metal screws provided in the kit. Ensure that no wires are pinched or caught between the cover and the plate.

INITIAL POWER UP

1. Plug the line cord into a source of A.C. power and turn it on. CPU Board indicators should illuminate.
2. The game will power up and begin self diagnostics. If no errors are found, the game will automatically enter its "attract" mode. Check wiring and refer to Troubleshooting (Section Four) if problems occur.
3. Unlock and open the coin door. Press the TEST button to enter the menu system. Select DIAGNOSTICS and choose SWITCH TESTS. Use this screen to verify that each switch and control operates properly. Refer to Operation (Section Two) for explanations of test conditions and results.
4. From the DIAGNOSTICS menu, choose MONITOR TESTS to confirm proper video display operation. If the monitor remote adjustment controls do not permit satisfactory picture quality to be obtained, the monitor may not be matched correctly to the CPU Board video circuits. Jumpers are included in some monitors to optimize the video impedance. Consult the video monitor manufacturer's literature for jumper information. See Operation (Section Two) for test steps or Troubleshooting (Section Four).
5. From the DIAGNOSTICS menu, choose DISK TESTS to examine the Hard Disk Drive. Run each of the tests in order to determine correct operation. The tests are described in Operation (Section Two).
6. From the DIAGNOSTICS menu, choose SOUND SUBSYSTEM TEST to check the audio circuitry. It may be necessary to raise the volume level higher than normal for this group of tests (Section Two).
7. From the DIAGNOSTICS menu, choose DIP-SWITCH TESTS to verify optimum switch positions.
8. From the DIAGNOSTICS menu, choose REAL TIME CLOCK to set the accurate time and date.
9. From the main menu, select EXIT to begin normal game operation. Open the coin door and press the SERVICE CREDITS button to allow game play. Press a START button and select a team to begin. Listen to the audio while playing the game. Note unexpected irregularities in sound (out of phase, no low frequencies, mono signals from stereo speakers, etc.). Check the wiring harness for internal shorts or strapped connections. Refer to Wiring (Section Three) or Troubleshooting (Section Four).
10. Close and lock the coin door. Replace the rear cabinet door. Allow the system to operate for several hours before attempting any game changes. Refer to Operation (Section Two) for adjustment steps.
11. When proper operation is confirmed, the game may be tested for FCC or other agency approval.

YOU ARE SOLELY RESPONSIBLE, AND MIDWAY WILL HAVE NO RESPONSIBILITY FOR FCC COMPLIANCE FOR INSTALLATIONS IN PRODUCTS OTHER THAN A MIDWAY UNIVERSAL VIDEO CABINET (MODEL 40135). THE FCC COMPLIANCE LABEL SUPPLIED MUST NOT BE INSTALLED ON THE CONVERTED PRODUCT UNTIL FCC COMPLIANCE IS VERIFIED.

CONTROL PANEL TEMPLATE
PLAYER 1

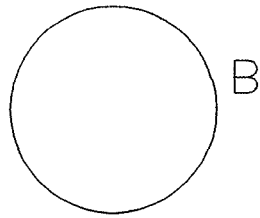

HOLE LEGEND	
SIZE AND TYPE	HOLE
.219" HOLE THRU	A
1.19" HOLE THRU	B
1.50" HOLE THRU	C

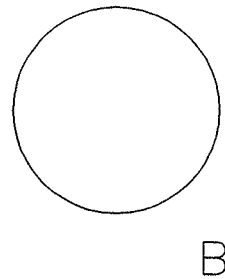
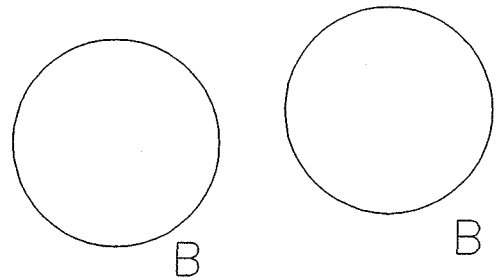
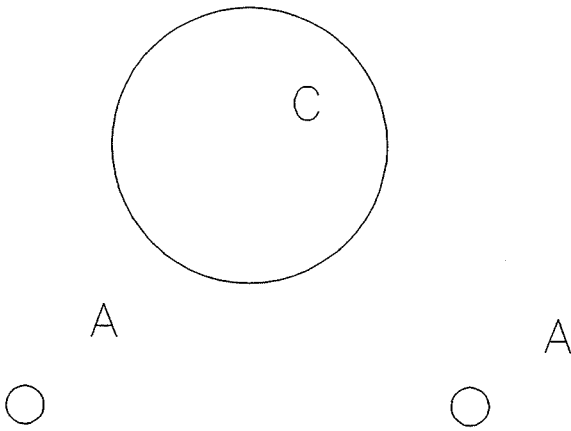

**CONTROL PANEL TEMPLATE
PLAYER 2**

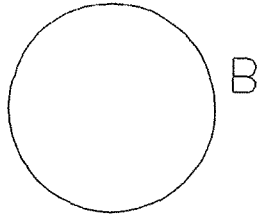

HOLE LEGEND	
SIZE AND TYPE	HOLE
.219" HOLE THRU	A
1.19" HOLE THRU	B
1.50" HOLE THRU	C

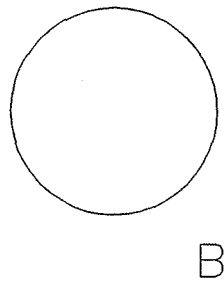
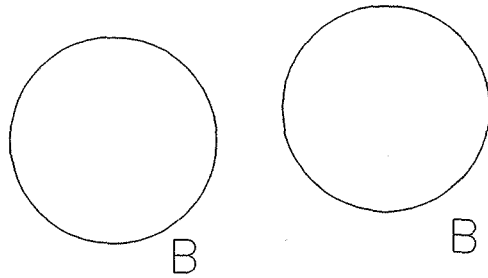
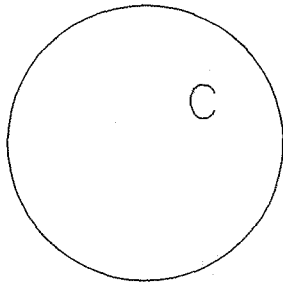

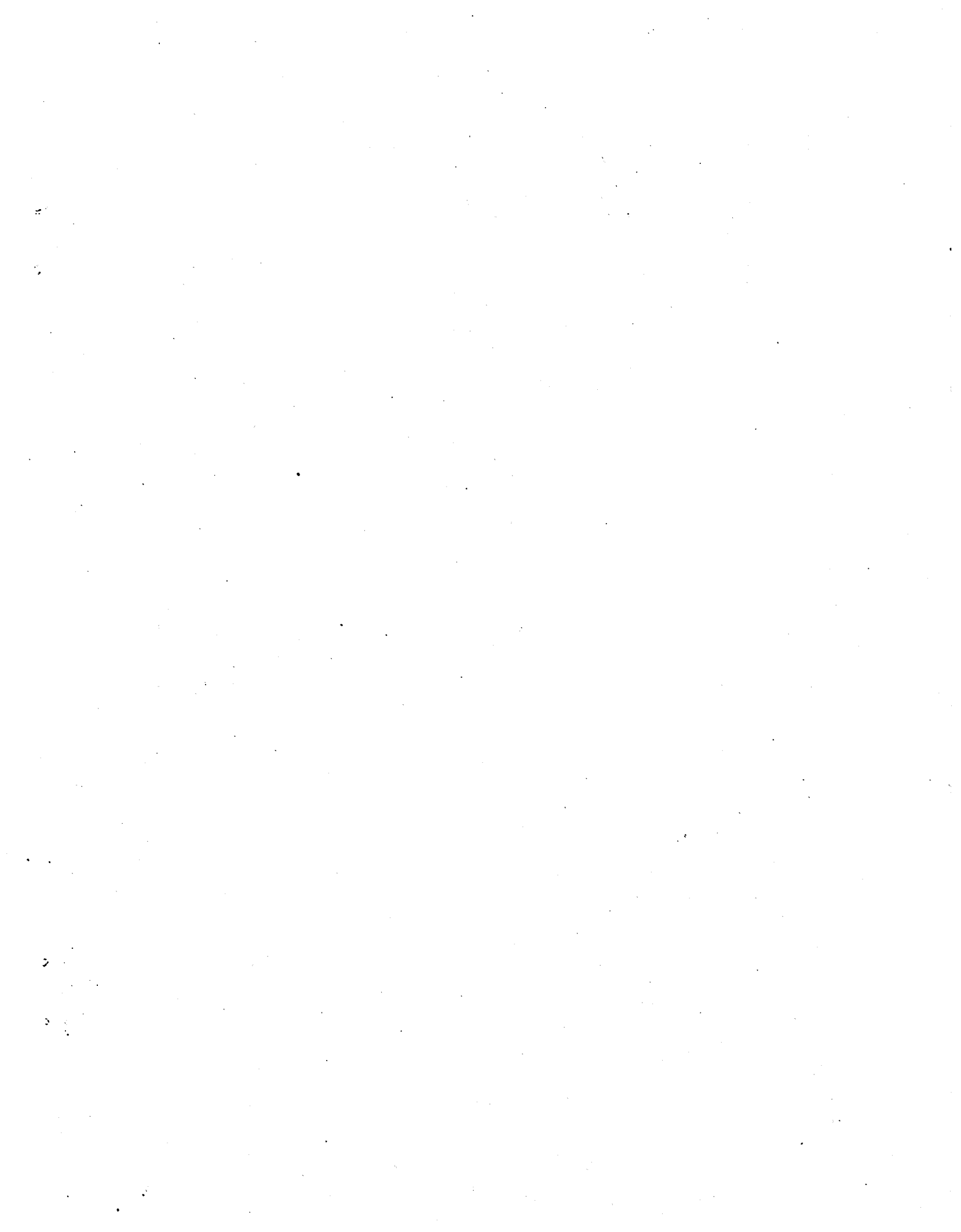

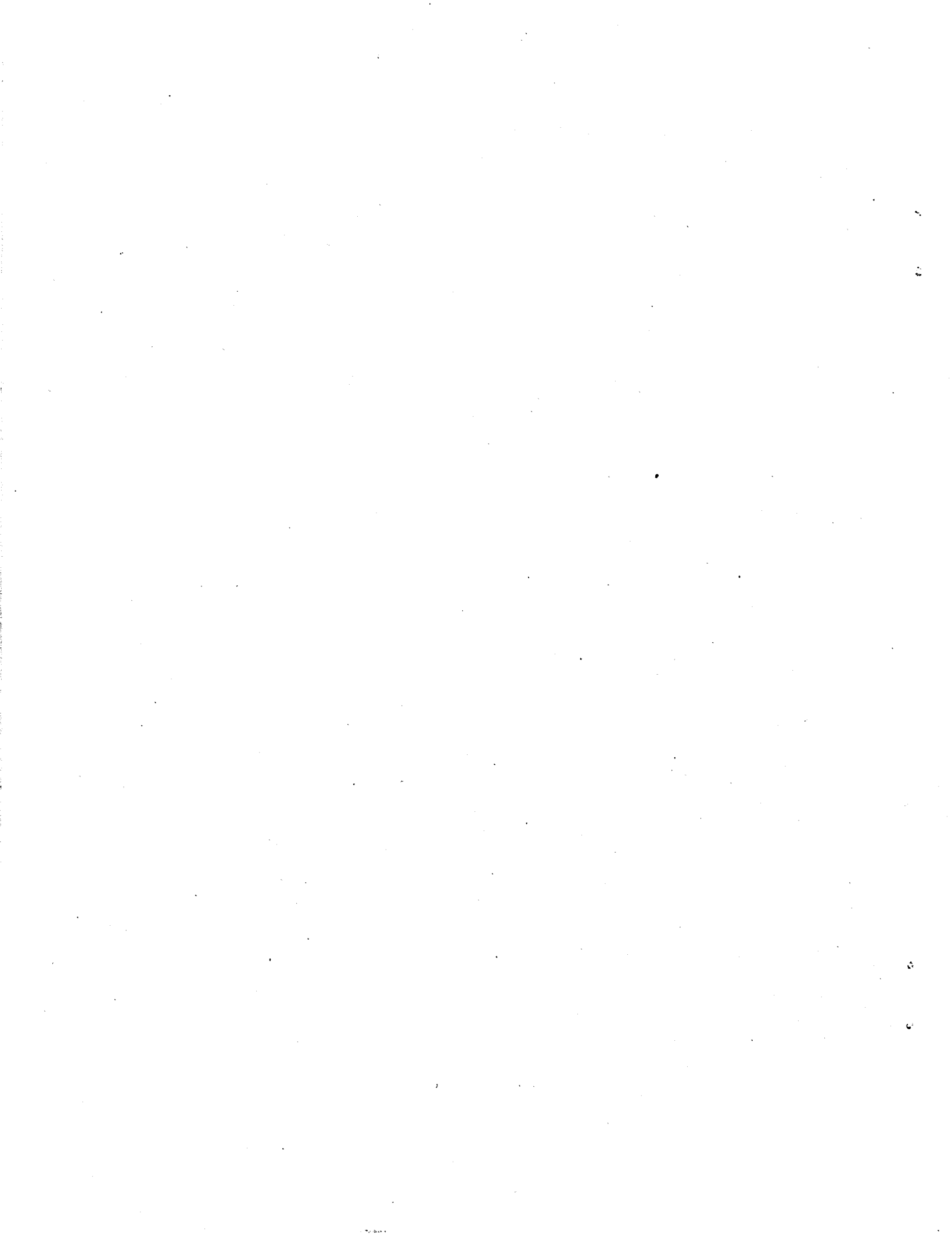

BLITZ KIT

SECTION TWO

OPERATION

NOTICE

Information in this manual is subject to change without notice. MIDWAY reserves the right to make improvements in equipment function, design, or components as progress in engineering or manufacturing methods may warrant.

Fill out and mail in the Game Registration card. Be sure to include the game serial number from the label on the rear of the cabinet. For your records, write the game serial number in the manual. SERIAL NUMBER _____

GAME OPERATION

STARTING UP

Each time the game is first turned on or power is restored, it begins executing code out of the boot ROM. These self-diagnostic tests automatically verify and report condition of the CPU and the game hardware. If any of the individual tests fails, then an error message will be displayed for each test.

Once all Power-up tests have been passed, the game goes into its "attract mode". Scenes and sounds from a typical game are alternated with previous high scores in an endless pattern until game play starts.

Insert currency to start the game. Players select teams and other game variables. Play begins after a countdown period is completed. The game will progress until time is exhausted. If no more play is required, the game automatically returns to the "attract mode".

GAME RULES *Play instructions are found on the information panel over and under the video monitor.*

INDIVIDUAL PLAY

Insert currency to start the game. Players may enter their names for future reference if desired. The teams are selected and the first play is run. An offensive or defensive play is chosen. Additional game information appears on the screen when needed. Team statistics are shown at the end of each quarter.

CONTROLLING CHARACTERS

The joystick and action buttons control the characters on the field. The joysticks used in this game respond to different amounts of deflection as well as direction, permitting fine control of character motion.

GAME ACTION

Standard league football rules apply, with two exceptions: 30 yards are required for first downs, and there are only 7 active team players. Game length and speed are determined by the game adjustment settings.

The player view of the action changes automatically whenever a better camera angle becomes available. Announcer comments and crowd noises are included in the game sounds.

SCORING

Points are awarded for touch downs, field goals, etc., just as in real live football games.

PLAYER CONTROLS (NOTE: Use joystick and button combinations to discover secret moves.)
The player controls are used to maneuver the team members and attack or defend against adversaries.

◆ **START Button**

This button allows players to begin or continue play. Use both buttons for a two player game.
This button has no dedicated function during game action or service.

◆ **JUMP / TACKLE Button**

This button lifts the offensive team member up or causes the defensive player to tackle opponents.
This same button is used to select items from the menus during service.

◆ **PASS / CHANGE PLAYER Button**

This button activates offensive throws. The defense move switches active control to another teammate.
This same button is used to select items from the menus during service.

◆ **TURBO Button**

The TURBO button gives any active character an extra burst of power or speed.
This same button is used to select items from the menus during service.

◆ **JOYSTICKS**

Each player has a joystick to control the movements of one on-screen character at a time.
The joystick is also used to select items from the menus during service.

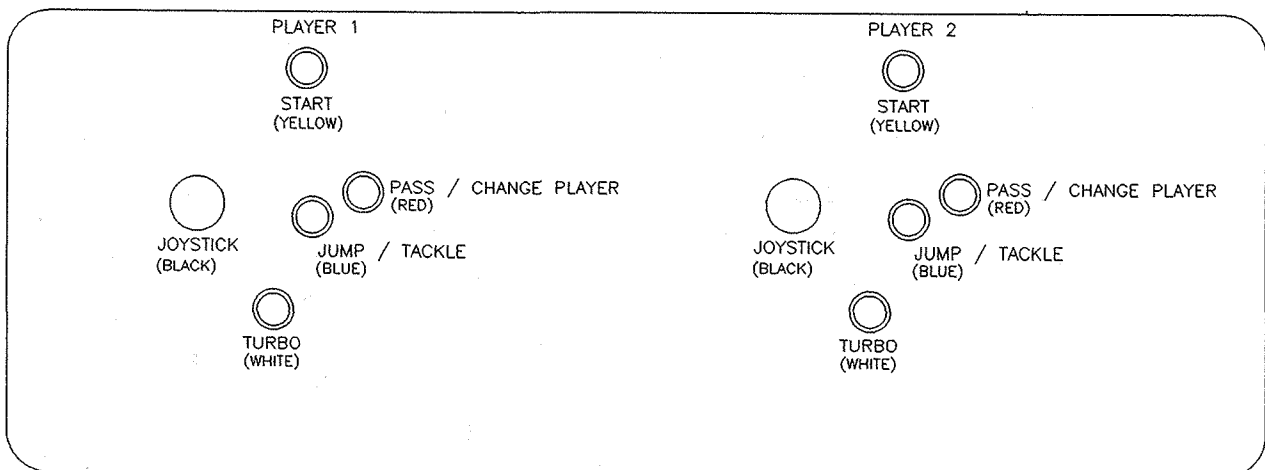

CONTROL LOCATIONS

OPERATOR CONTROLS

Access to the menu system for statistics, adjustments, or testing is secured by lock and key to prevent tampering. When the menu system is entered, on screen messages guide the operator through tasks.

CABINET SWITCHES

- ◆ **Power Switch**
The **Power Switch** turns off the game during service. It does not reset the game variables.
- ◆ **Slam Tilt Switch**
The **Slam Tilt** switch prevents game abuses such as pounding to obtain free games.
- ◆ **Monitor Remote Adjustments** (inside the cabinet under the monitor)
The **Monitor Remote Adjustment Board** sets the video display for optimum viewing.

CONTROL SWITCHES

- ◆ **Volume Down and Volume Up Buttons**
The **Volume Down** and **Volume Up** push-button switches increase or decrease game sound levels. Press either button briefly to make minor changes. Press and hold a button to make major changes. Volume may also be changed with the joysticks and buttons when the menu system is active.

NOTE

For greater profits, adjust your volume levels to a loud setting to draw attention to this game.

- ◆ **Service Credit Button**
The **Service Credit** push-button switch allots credits without changing the game's bookkeeping total.
- ◆ **Begin Test Button**
The **Begin Test** push-button switch enters the menu system. Press the Begin Test button briefly to run the automatic tests. Press and hold the Test button to get to any of the menu selections. The Test Mode may also be entered by setting one of the CPU Board switches (refer to DIP-Switch Test).

NOTE

The coin door must be open to reach the control switches.

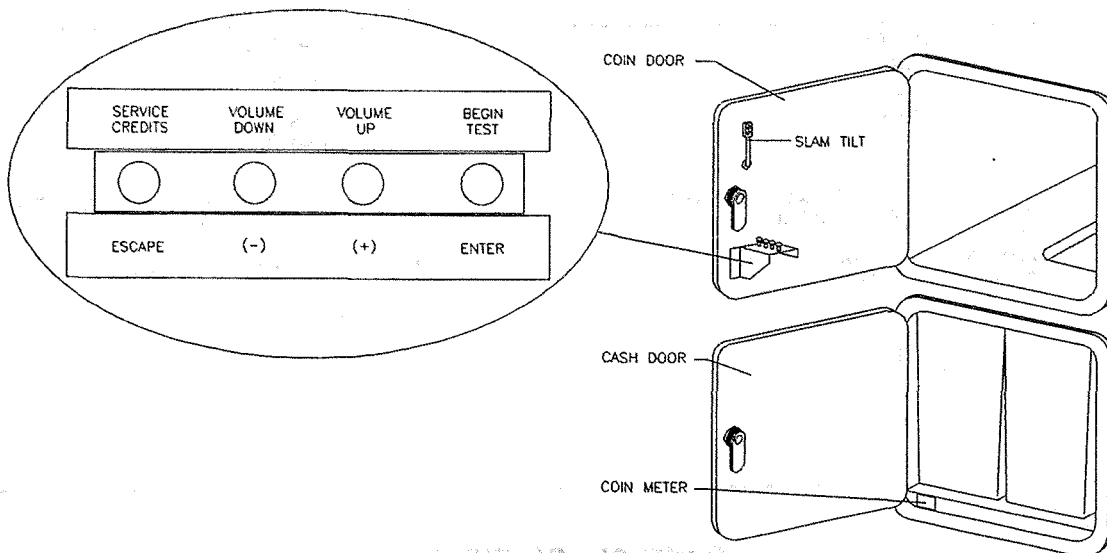

TYPICAL CONTROL SWITCH LOCATIONS

MENU SYSTEM

SYSTEM OVERVIEW

Game variables and diagnostics are presented in a series of on-screen menus. The Main Menu screen allows the operator to view information, make changes, or verify equipment operation. Each Sub Menu screen displays one specific group of choices. The Detail Menu presents data or runs the required test. You must be at the Detail Menu level to detect errors, make changes, or activate tests. Both the operator controls and the player controls are used to move through the menus and start or stop particular routines.

Each time the game is switched from normal play mode to the menu system and back, the self-diagnostic routine is activated. These basic tests run automatically; their purpose is to detect those faults that would prevent the game or the menu system from operating properly. Messages appear on the screen as each item is run, along with any errors detected. A successful self-test usually takes less than one minute to complete. Write down any messages before proceeding to the menus or game play.

SCREEN LAYOUT

Each menu screen is different, but the material presented stays in the same physical location each time.

The color bar at the top center of each screen displays the current menu title.

The center of the screen is used for data (menu items, video signals, statistics, reports, etc.)

The bottom of the screen is for messages (explanations, control functions, revision levels, etc.)

ORGANIZATION

The menu system must be activated manually. It must also be deactivated manually to play the game.

Main Menu screen items are divided into categories: tests, statistics, audits, adjustments, etc.

Tests are useful to verify proper operation of the equipment assemblies one at a time.

Other items allow operators to assess game performance and customize or return to factory defaults.

Sub Menu screen items offer the operator choices within a category. Some items have no Sub Menu while others may have more than one. You can get back to the previous menu or go on to the next menu.

Detail Menu screen items contain specific information. The operator must interact with the system to get results or to make changes. There is always a way to go back to the previous menus from this screen.

Control functions are listed on screen. Use the joysticks to highlight an item on any menu. Only one highlighted item can be selected at a time. Press the indicated button to select a highlighted item. To return the game to normal, use the joysticks to select EXIT TO GAME OVER, then press an action button.

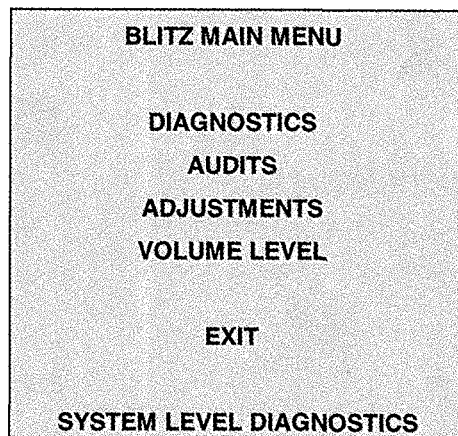

MAIN TEST MENU

DIAGNOSTICS

These tests allow the operator to verify the condition of the electrical and electronic hardware in the game.

To select these tests, use a joystick to pick DIAGNOSTICS and a control panel button to activate it. The screen displays the sub menu. Use the same steps to activate any one of the items listed.

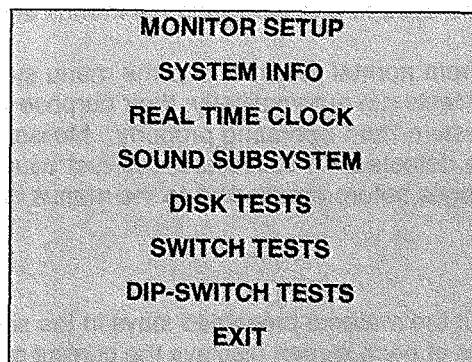

DIAGNOSTICS SUB MENU

It is recommended to go through each of these items at least once before releasing the game to players. This permits the new electronics to be optimized to the converted cabinet.

MONITOR SETUP

The Monitor Patterns routine provides test screens to verify monitor performance or make adjustments.

NOTE: A medium resolution monitor is the recommended type of video display. The increased resolution means that there is more video information on the screen than standard monitors. Use of an industrial grade degaussing coil is recommended before any corrections to monitor adjustments are attempted.

Highlight the test by using any joystick to select the option; then press any control panel button to activate.

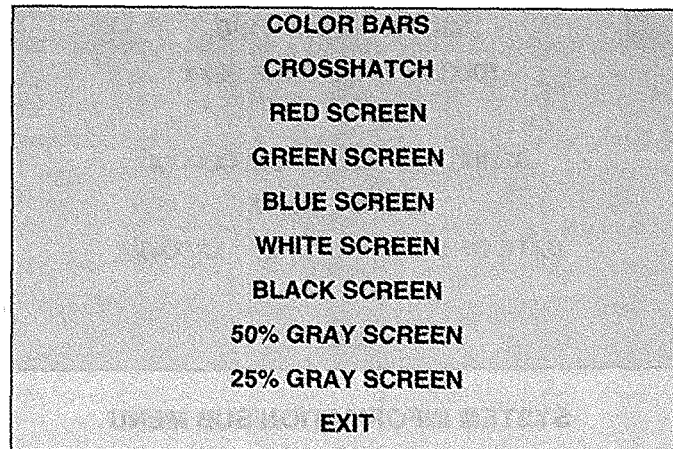

MONITOR SETUP SUB MENU

Color Bars fills the screen with shades of colors to verify red, green, blue and white level dynamic adjustments. Each color bar should appear sharp, clear, and distinct from bars on either side.

There are 31 levels of intensity displayed in each color bar. Incorrect adjustment can cause detail to be missing at the top or bottom of a bar. Set the controls so that all levels are visible in every color bar.

The Color Bars screen is useful in adjusting the monitor brightness and contrast.

Crosshatch Patterns fill the screen with a grid and a series of dots. The grid and the dots should be all white in color, with no fringes or parallel images. The lines should be straight and the dots round.

Consult the service literature from the manufacturer of the monitor for more detail on these adjustments.

The Crosshatch Patterns are useful in verifying the monitor convergence, linearity, and dynamic focus.

Color Screen tests fill the screen with 100% of the chosen color at normal intensity. Each screen should be absolutely uniform from top to bottom and side to side. No retrace lines or noise should be visible.

The Color Screen tests are useful in verifying monitor intensity, black level, blanking and color purity.

Color Screens may not hold their uniformity if the monitor degaussing circuit is defective.

White, Gray, and Black Screens fill the screen with black, gray or white at various intensities. The screens should be uniform with no color tints or distortion. No retrace lines or noise should be visible.

If any of the tests shows a need for adjustment, use the proper controls on the Monitor Controls board.

NOTE: Ensure that the Graphics Mode setting matches the monitor type (refer to DIP Switch Tests).

SYSTEM INFORMATION

The System Information provides the current version numbers of the hardware and software installed in this game. Use these numbers to describe the system during parts replacements, service calls, etc.

Highlight the test by using any joystick to select the option; then press any control panel button to activate.

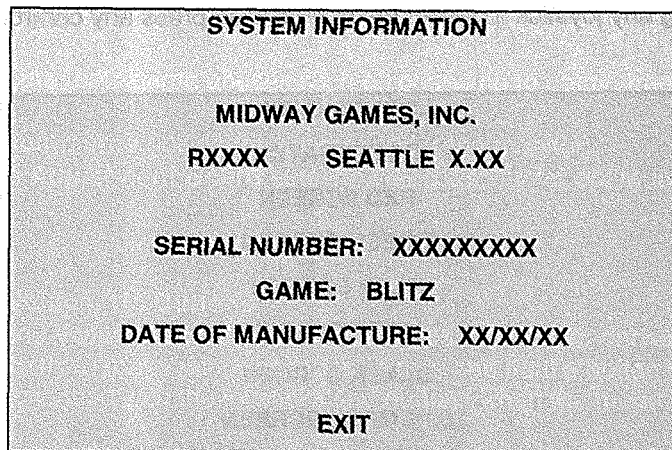

SYSTEM INFORMATION SUB MENU

This screen reports information but does not permit changes to be made.

The Title line identifies the manufacturer of this game and the electronic board set used in this product.

The Serial Number, Game, and Date of Manufacture identify the game name and production run.

REAL TIME CLOCK

The Real Time Clock provides the current date and time for the game. This screen also allows operators to adjust the clock for changes in time zones, clock resets, etc.

Highlight the test by using any joystick to select the option; then press any control panel button to activate.

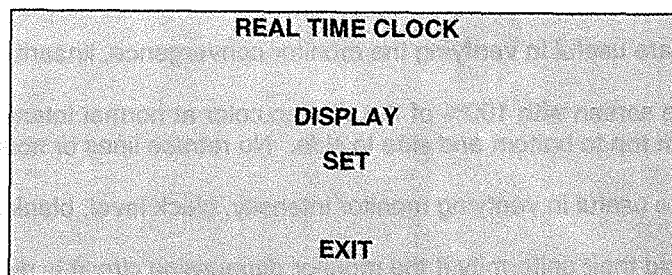

REAL TIME CLOCK SUB MENU

The clock is used to provide accurate game statistics. The clock does not affect the game operation.

Once set, the clock will run until the battery dies or circuits are disrupted by service or some major fault. Periodically examine the top lines of the SELF TEST screen for the correct time and date.

SOUND SUBSYSTEM TEST

The Sound Subsystem Tests verify that the audio components are connected and operating properly.

Highlight the test by using any joystick to select the option; then press any control panel button to activate.

NOTE: The level must be turned up for speakers to be heard. Check the volume setting before testing.

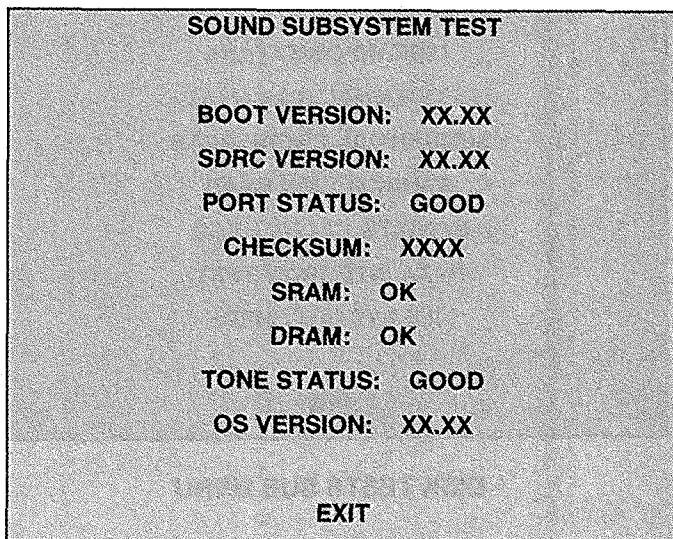

SOUND SUBSYSTEM SUB MENU

Version, status, checksum, and RAM reports are a series of diagnostic routines that analyze the digital sound circuits. The results of the tests will be reported as numbers or messages; sounds may also accompany some of the tests. Reports other than GOOD or OK may indicate a problem has been found.

The Sound Subsystem Tests are useful in locating digital circuit difficulties, especially when there is no sound from the speakers with the volume set at high levels. These tests detect sound memory problems.

DISK TESTS

The Disk Tests allow the operator to verify the functions of the Hard Disk Drive Assembly.

Highlight the test by using any joystick to select the option; then press any control panel button to activate.

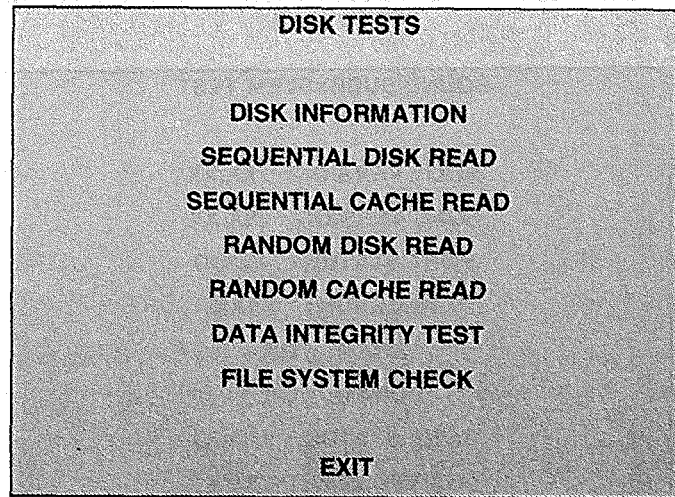

DISK TESTS SUB MENU

Disk Information

This test routine verifies the interface between the CPU Board Assembly and the Hard Disk Drive itself. The processor requests disk information. Data cannot be retrieved successfully if there is a problem.

Sequential Disk Read

This routine tries to access every bit of data in the order it is stored directly on the disk (requires less than 30 seconds). The hard disk drive media may be defective if this routine cannot be completed successfully.

Sequential Cache Read

This routine tries to access every bit of data in the order it is stored in the temporary disk memory cache (approximately 30 seconds). There may be a fault in the memory circuits if this test is not successful.

Random Disk Read

This routine tries to access every bit of data in no particular order directly from the disk (requires less than 30 seconds). This test may detect problems with ability to position the drive heads accurately over data.

Random Cache Read

This routine tries to access every bit of data in no particular order from the temporary disk memory cache (approximately 30 seconds). There may be a fault in the memory circuits if this test is not successful.

Data Integrity Test

This test will analyze the data on the disk drive. This endless test determines if corrupted data is on the disk. Bad data can cause the program to falter even though the hard disk drive is operating correctly.

File System Check

This routine will perform a file-by-file check of the data stored on the hard disk drive. If errors are detected the system tries to fix them, then checks the files again. This test takes about 30 seconds (with no errors).

SWITCH TEST

To enter the test, use a joystick to select the Switch Test and any control panel button to begin testing. Activate each switch and the indicator on the screen changes state. Release the switch and the indicator returns to its previous normally open or closed condition. Switches may be tested in any combination.

PLAYER SWITCH INPUTS TEST					
P1	UP	<input type="checkbox"/>	PLAYER 1 49-WAY	LEFT COIN	<input type="checkbox"/>
P1	DOWN	<input type="checkbox"/>	XX	RIGHT COIN	<input type="checkbox"/>
P1	LEFT	<input type="checkbox"/>		P1 START	<input type="checkbox"/>
P1	RIGHT	<input type="checkbox"/>		SLAM/TILT	<input type="checkbox"/>
P1	JUMP	<input type="checkbox"/>		TEST/ENTER	<input type="checkbox"/>
P1	PASS	<input type="checkbox"/>		P2 START	<input type="checkbox"/>
P1	TURBO	<input type="checkbox"/>		SERVICE/CREDIT	<input type="checkbox"/>
P2	UP	<input type="checkbox"/>	PLAYER 2 49-WAY		
P2	DOWN	<input type="checkbox"/>	XX		
P2	LEFT	<input type="checkbox"/>		VOLUME UP	<input type="checkbox"/>
P2	RIGHT	<input type="checkbox"/>		VOLUME DOWN	<input type="checkbox"/>
P2	JUMP	<input type="checkbox"/>			
P2	PASS	<input type="checkbox"/>		BILL VALIDATOR	<input type="checkbox"/>
P2	TURBO	<input type="checkbox"/>			

SWITCH TEST SCREEN

Player Controls are shown on the screen as colored boxes. Red boxes indicate an open state, green indicates closed; any other color indicates a fault condition. Each button or joystick change should be exactly duplicated by a single indication on the menu screen.

The game electronics will accept both deluxe (49-way) and standard (8-way) joysticks. The active joystick type will be indicated on the test screen. For 49-way joysticks (as illustrated in the example above), there will be a unique number for each Player 1 or Player 2 joystick position recognized by the game electronics. Standard joysticks will indicate each individual position, but there will be no numerical value displayed.

The Player Controls Tests are used to verify crossed wires, intermittent conditions, and stuck switches.

Operator Controls are shown on the screen as they are found on the coin door. Colors are the same as above. Each switch change should be exactly duplicated by a single indication on the menu screen.

The Operator Controls Tests are used to verify crossed wires, intermittent conditions, and stuck switches.

The Coin and Cabinet Switches are shown on the screen without regard for their actual game location. Each switch change should be exactly duplicated by a single indication on the menu screen.

These Switch Tests are used to verify crossed wires, intermittent conditions, and stuck switches.

NOTE: Ensure that the Joystick Type setting matches the joysticks used (refer to DIP Switch Tests).

DIP-SWITCH TEST

The DIP-Switch Test allows operators to check the position of the two 8-position DIP-switches on the CPU Board. The operator can also change the setting of any DIP-switch without removing the CPU cover.

To enter the test, use a joystick to select the DIP-switch Test and any control panel button to activate it. The screen displays an illustration of each switch block. Some switch positions may show as unused.

DIP-switches may be changed with the power on. Set any switch, then check the screen to verify that the new setting is now enabled. Country switch settings have no effect if CMOS Coinage Control is set to On.

Refer to the charts for assistance in choosing the desired switch positions (* indicates factory defaults). Graphics Mode 512 x 256 15KHz is best for most standard resolution video game monitors; the factory default Graphics Mode 512 x 384 25KHz is correct for most medium resolution video game monitors. Incorrect settings will affect other test results. Press any control panel button to exit the DIP-switch Test.

DIP Switch 1 (U9)			SW1	SW2	SW3	SW4	SW5	SW6	SW7	SW8
Coinage DIPSwitch Control		CMOS	Off On*							
USA1	Ger1	Fr1		Off*	Off*	Off*				
USA2	Ger2	Fr2		Off	Off	On				
USA3	Ger3	Fr3		Off	On	Off				
USA4	Ger4	Fr4		Off	On	On				
USAECA	GerECA	FrECA		On	Off	Off				
N/U	N/U	N/U		On	Off	On				
N/U	N/U	N/U		On	On	Off				
Free Play	Free Play	Free Play		On	On	On				
USA							Off*	Off*		
French							On	Off		
German							Off	On		
Unused							On	On		
Unused									Off*	
Unused									On	
Power Up Test Loop	One									Off*
Time										On
Power Up Test Loop										
Continuous										

DIP Switch 2 (U8)			SW1	SW2	SW3	SW4	SW5	SW6	SW7	SW8
Joystick Type	8-		Off On*							
Way										
Joystick Type	49-									
Way										
Unused				Off	Off					
Graphics Mode 512 x 256				On	Off					
15KHz										
Graphics Mode 512 x 384				Off*	On*					
25KHz				On	On					
Unused										
Graphics Speed						Off*	Off*			
51MHz						On	Off			
Graphics Speed										
49MHz										
Graphics Speed						Off	On			

47MHz Graphics Speed 45MHz		On	On			
Bill Validators Installed None Bill Validators Installed One				Off* On		
Power Up Test Active Power Up Test Inactive					Off* On	
Test Manual Mode Forced						Off* On

AUDITS

The Audits menus permit the operator to review the game play statistics. Additional menus give detailed reports for each player position on game starts, ends, cabinet abuse, fault conditions, etc.

To enter the test, use a joystick to select the Audits menu and any control panel button to activate it. The screen displays a list of the statistics available to the operator. Select an item to view the detailed report.

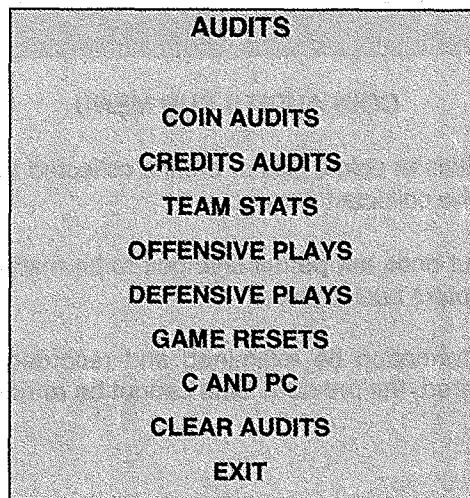

AUDITS SUB MENU

Use the information in the Audits menus to keep records of the game's popularity and earning potential. The operator may also track favorite teams, most frequently used offensive and defensive plays, etc.

NOTE: Once data has been cleared, it cannot be restored. Use caution when clearing audit information.

COIN AUDITS

The Coin Audits menu permits the operator to assess the currency collection. This report screen presents revenue quantities and other important game statistics.

Highlight Coin Audits by using any joystick to select the option; then press any control panel button to activate this choice. A menu screen is shown below.

COIN AUDITS	
LEFT SLOT COINS	XXXXXXXX
RIGHT SLOT COINS	XXXXXXXX
BILLS	XXXXXXXX
CENTER SLOT COINS	XXXXXXXX
EXTRA SLOT COINS	XXXXXXXX
GAME STARTS	XXXXXXXX
MID-GAME STARTS	XXXXXXXX
SERVICE CREDITS	XXXXXXXX
TOTAL PLAYS	XXXXXXXX
TOTAL PAID CREDITS	XXXXXXXX
TOTAL	XXXXXXXX

COIN AUDITS SUB MENU

The sub menu reports total quantities of coins, bills or credits collected by each active device in the game. It does not calculate the value of the collected currency.

This screen reports information but does not permit changes to be made. Go to the Game Resets menu to set the coin, bill, and credit counters back to zero.

We recommend that all audit information be examined and recorded before any changes are made. Once the counters have been cleared, the previous data cannot be retrieved from the system.

CREDITS AUDITS

The Credits Audits menu permits the operator to assess the currency collection. This report screen presents revenue quantities and other important game statistics.

Highlight Coin Audits by using any joystick to select the option; then press any control panel button to activate this choice. A menu screen is shown below.

CREDITS AUDITS	
CREDITS AVAILABLE	XXXXXXXX

CREDITS AUDITS SUB MENU

GAME AUDITS

The Game Audits Menus permit the operator to review the game play statistics.

Highlight Game Audits by using any joystick to select the option; then press any control panel button to activate this screen.

GAME AUDITS

TOTAL UPTIME
TOTAL PLAY TIME
GAME STARTS
INITIALS ENTERED
<FG> PURCHASED AT START
1 PLAYER
2 PLAYER
1 QUARTER GAMES
2 QUARTER GAMES
3 QUARTER GAMES
4 QUARTER GAMES
1 OVERTIME
2 OVERTIMES
3 OVERTIMES
AVG. HUMAN TO HUMAN SCORE <FG>
AVG. HUMAN TO COMPUTER SCORE <FG>
AVG. HUMAN TO HUMAN WIN SCORE <FG>
AVG. HUMAN TO HUMAN LOSS SCORE <FG>
COMPUTER VICTORIES <FG>
GREATEST COMPUTER VICTORY MARGIN <FG>
GREATEST COMPUTER LOSS MARGIN <FG>
HUMAN TO HUMAN LSW'S
GAME CONTINUES
FREE QUARTERS AWARDED
FREE GAMES AWARDED
TLF'S
SBLF'S

GAME AUDIT SUB MENU

This screen reports information but does not permit changes to be made.

We recommend that all audit information be examined and recorded before any changes are made. Once the counters have been cleared, the previous data cannot be retrieved from the system.

<FG> is used here to indicate a Full Game.

LSW, TLF, SBLF, etc. are terms for internal record keeping counters used in this game.

CLEAR AUDITS

The Clear Audits menu allows you to clear individual memory counters or to reset them all at one time.

Use the joysticks to select a particular game option. Joysticks are also used to view the range of choices and change values. Options may be reset to factory defaults or changed after each viewing.

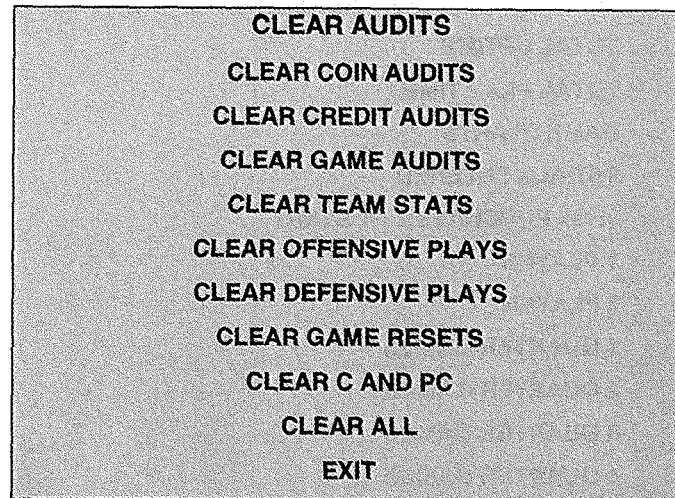

CLEAR AUDITS SUB MENU

Any of the audit screens may be reset from this menu. Choose any item to return the counters to zero.

Coin, Credit, and Game Audits have been examined in detail on the preceding pages.

Team Stats shows the number of games played by each team in the league.

Offensive and Defensive Plays analyzes the strategies favored by the players.

Game Resets keeps track of how the game responds to different player maneuvers.

C and PC is an internal record keeping list used to monitor game performance.

Clear All changes all audit categories to the factory default values simultaneously.

After an item has been selected, you are given the opportunity to escape from this change. For example:

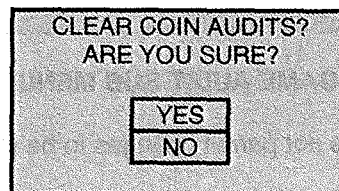

LAST CHANCE SUB MENU

Once any clear function has been selected and verified, the values are reset and can not be restored.

We recommend that all utility values be examined and recorded before any changes are made.

ADJUSTMENTS

The Adjustments menus permit the operator to change the game characteristics. Use these screens to optimize game performance and earnings.

To enter the test, use a joystick to select the Adjustments menu and any control panel button to activate it.



ADJUSTMENTS SUB MENU

PRICING

The Pricing menus allow the operator to view current settings or change the cost of games. Custom pricing allows the operator to select the specific number of coins or credits required for each game. Factory default values are restored if the CPU Board is exchanged or the back up battery fails.

Use the joysticks to select a particular game option. Joysticks are also used to view the range of choices and change values. Options may be reset to factory defaults or changed after each viewing.

We recommend that all pricing options be examined and recorded before any changes are made.

Operators may save several custom prices and then choose between them as needed. Instructions for creating new price settings appear on the screen in sequence to guide you through the custom process.



PRICING SUB MENU

An additional box appears on screen to explain the functions available as each item is selected.

CURRENT PRICING

CURRENT PRICING	
LEFT SLOT UNITS	XX
RIGHT SLOT UNITS	XX
CENTER SLOT UNITS	XX
EXTRA SLOT UNITS	XX
BILL VALIDATOR UNITS	XX
UNITS PER CREDIT	XX
UNITS PER BONUS	XX
MINIMUM UNITS	XX
CREDITS TO START	XX
CREDITS TO CONTINUE	XX
MAXIMUM CREDITS	XX
COINS PER BILL	XX

CURRENT PRICING SUB MENU

The following definitions are provided to better explain the adjustments in the Pricing menus:

Slot or Bill Units:	Coins and bills inserted accumulate units. This adjustment specifies the quantity of units given for each coin or bill in each position ("unit" is an arbitrary term).
Units per Credit:	This number establishes the value of each credit for pricing calculations.
Units per Bonus	Units awarded after a player has accumulated enough points for a bonus.
Minimum Units:	No credits will be awarded until this many coin or bill units have accumulated.
Credits to Start:	Credits needed to begin game play. This sets the basic cost per game.
Credits to Continue:	Credits required to continue a game which is already in progress.
Maximum Credits:	Sets limits on the number of credits that the game will accept.
Coins per Bill:	Establishes value for bills by comparing them to an equivalent number of coins.

ADDITIONAL ADJUSTMENTS

The Additional Adjustments menu items allow the operator to set the game to match the requirements of the players. These adjustments affect speed, challenge, rewards, etc. that determine player enjoyment.

Highlight item choice with any joystick, then press any button select that item.

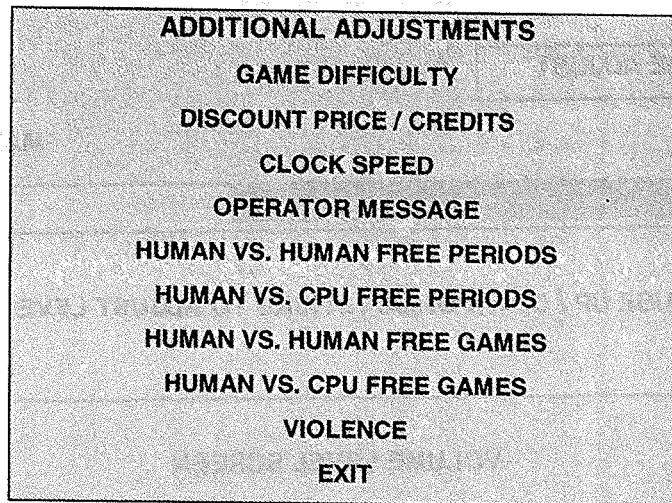

ADDITIONAL ADJUSTMENTS SUB MENU

Game Difficulty has several levels. Choose one that most closely matches the skills of the players.

Discount Price / Credits adjusts the quantity buy-in points to encourage multiple game purchases.

Clock Speed changes the length of each quarter in the game, and this determines total game time.

Operator Message can be entered in advance and turned on at the appropriate day and time.

Free Periods and Free Games can be used to provide additional incentives to good players.

Violence may be removed from the game without affecting any other game play characteristics.

VOLUME LEVEL

Music plays continuously with this screen. Use any joystick or the volume buttons to change the sound level of the game. Press any control panel button to save the volume level and return to the Main Menu.

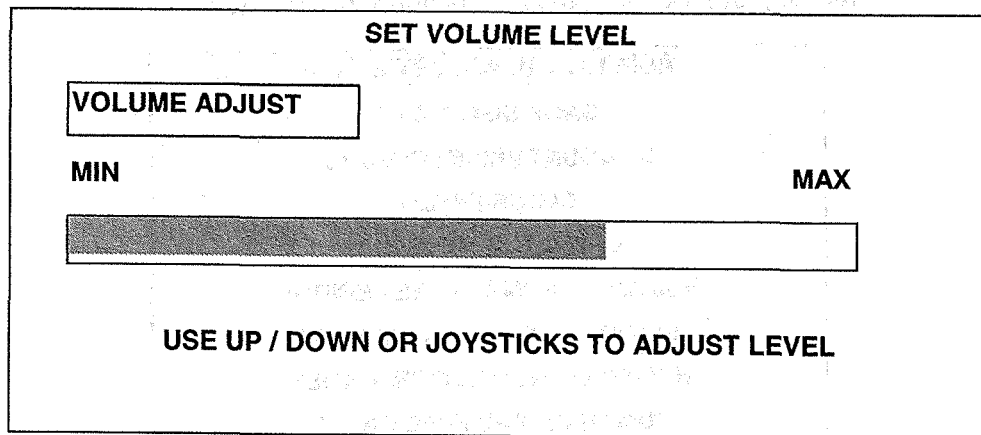

VOLUME LEVEL SCREEN

Loud games attract more player interest than low levels. The Attract sound level is lower than game play.

The Attract sound can be turned On or Off without changing the game volume level (see Adjustments).

NOTE: These adjustments affect the volume of the tests as well as the game play. If the volume levels are set to minimum (zero), there will be no sounds from the speakers during any of the audio tests. It is recommended that the volume levels be set to a moderately high value each time the sound portion of the game or the speakers are checked. The levels may be returned to their previous settings after the tests have been completed.

STANDARD PRICING TABLE

NAME	START	CONTINUE	CREDITS/COIN	COIN 1	COIN 2	COIN 3	COIN4	BILL
USA1	2	2	1/25¢	.25¢	.25¢			\$1.00
USA2	2	1	1/25¢	.25¢	.25¢			\$1.00
USA3	1	1	1/25¢	.25¢	.25¢			\$1.00
USA4	1	1	1/50¢, 3/\$1.00	.25¢	.25¢			\$1.00
USA5	2	1	1/50¢, 4/\$1.00	.25¢	.25¢			\$1.00
USA6	1	1	1/50¢	.25¢	.25¢			\$1.00
USA7	1	1	1/50¢, 3/\$1.00	.25¢	.25¢			\$1.00
USA8	2	2	1/50¢, 4/\$1.00	.25¢	.25¢			\$1.00
USA9	3	2	1/25¢, 4/\$1.00	.25¢	.25¢			\$1.00
USA10	3	3	1/25¢, 4/\$1.00	.25¢	.25¢			\$1.00
USA ECA	3	3	1/25¢, 4/\$1.00	\$1.00	.25¢	.10¢	.05¢	\$1.00
GERMAN1	2	2	1/1DM, 6/5DM	1DM	5DM			
GERMAN2	2	1	1/1DM, 7/5DM	1DM	5DM			
GERMAN3	2	1	1/1DM, 8/5DM	1DM	5DM			
GERMAN4	2	1	1/1DM, 5/5DM	1DM	5DM			
GERMAN5	2	1	1/1DM, 6/5DM	1DM	5DM			
GERMAN ECA	2	2	1/1DM, 2/2DM, 6/5DM	5DM	2DM	1DM		
FRANCE1	2	2	2/5Fr, 5/10Fr	5Fr	10Fr			
FRANCE2	2	1	2/5Fr, 4/10Fr	5Fr	10Fr			
FRANCE3	2	1	1/5Fr, 3/10Fr	5Fr	10Fr			
FRANCE4	2	1	1/5Fr, 2/10Fr	5Fr	10Fr			
FRANCE5	2	1	2/5Fr, 5/10Fr, 11/2 X 10Fr	5Fr	10Fr			
FRANCE6	2	1	2/5Fr, 4/10Fr, 9/2 X 10Fr	5Fr	10Fr			
FRANCE7	2	1	1/5Fr, 3/10Fr, 7/2 X 10Fr	5Fr	10Fr			
FRANCE8	2	1	1/5Fr, 2/10Fr, 5/2 X 10Fr	5Fr	10Fr			
FRANCE9	2	1	1/3 X 1Fr, 2/5Fr	1Fr	5Fr			
FRANCE10	2	1	1/2 X 1Fr, 3/5Fr	1Fr	5Fr			
FRANCE11	2	1	1/3 X 1Fr, 2/5Fr, 5/2 X 5Fr	1Fr	5Fr			
FRANCE12	2	1	1/2 X 1Fr, 3/5Fr, 7/2 X 5Fr	1Fr	5Fr			
FRANCE ECA	2	2	1/3 X 1Fr, 2/5Fr, 5/2 X 5Fr	1Fr	5Fr	10Fr	20Fr	
CANADA	2	2	1/2X25¢, 3/\$1.00	.25¢	\$1.00			\$1.00
SWISS1	2	2	1/1SFr, 6/5SFr	1SFr	5SFr			
SWISS2	2	2	1/1SFr, 7/5SFr	1SFr	5SFr			
SWISS3	2	2	1/1SFr, 8/5SFr	1SFr	5SFr			
ITALY	2	2	1/500Lit	500Lit	500Lit			
UK ECA1	1	1	1/50p, 3/£1.00	£1.00	50p	20p	10p	
UK ECA2	1	1	1/50p, 2/£1.00	£1.00	50p	20p	10p	
UK ECA3	1	1	1/30p, 2/50Pta, 5/£1.00	£1.00	50p	20p	10p	
UK4	1	1	1/50p, 3/£1.00	£1.00	50p			
UK5	1	1	1/50p, 2/£1.00	£1.00	50p			
SPAIN1	2	2	1/100Pta, 6/500Pta	100Pta	500Pta			
SPAIN2	2	2	1/100Pta, 5/500Pta	100Pta	500Pta			
AUSTRALIA1	2	2	1/3X20¢, 2/\$1.00	.20¢	\$1.00			
AUSTRALIA2	2	2	1/5X20¢, 1/\$1.00	.20¢	\$1.00			
JAPAN1	2	2	1/100Yen	100 Yen	100 Yen			
JAPAN2	2	2	2/100Yen	100 Yen	100 Yen			
AUSTRIA1	2	2	1/5Sch, 2/10Sch	5 Sch	10 Sch			
AUSTRIA2	2	2	1/2X5Sch, 3/2X10Sch	5 Sch	10 Sch			
BELGIUM1	2	2	1/20BF	20BF	20BF			
BELGIUM2	2	2	3/20BF	20BF	20BF			
BELGIUM3	2	2	2/20BF	20BF	20BF			
BELGIUM ECA	2	2	1/20BF	50BF	20BF	5BF		
SWEDEN	2	2	1/3X1SKr, 2/5SKr	1SKr	5SKr			
NEW ZEALAND1	1	1	1/3X20¢	20¢	20¢			
NEW ZEALAND2	1	1	1/2X20¢	20¢	20¢			
NETHERLANDS	2	2	1/1HFl, 3/2.5HFl	1HFl	2.5HFl			
FINLAND	2	2	1/1Fmk	1Fmk	1Fmk			
NORWAY	2	2	1/2X1NKr, 3/5X1NKr	1NKr	1NKr			
DENMARK	2	2	1/2X1DKr, 3/5DKr, 7/2X5DKr	1DKr	5DKr			
ANTILLIES	2	2	1/25¢, 4/1G	.25¢	1G			
HUNGARY	2	2	1/2X10Ft, 3/2X20Ft	10Ft	20Ft			

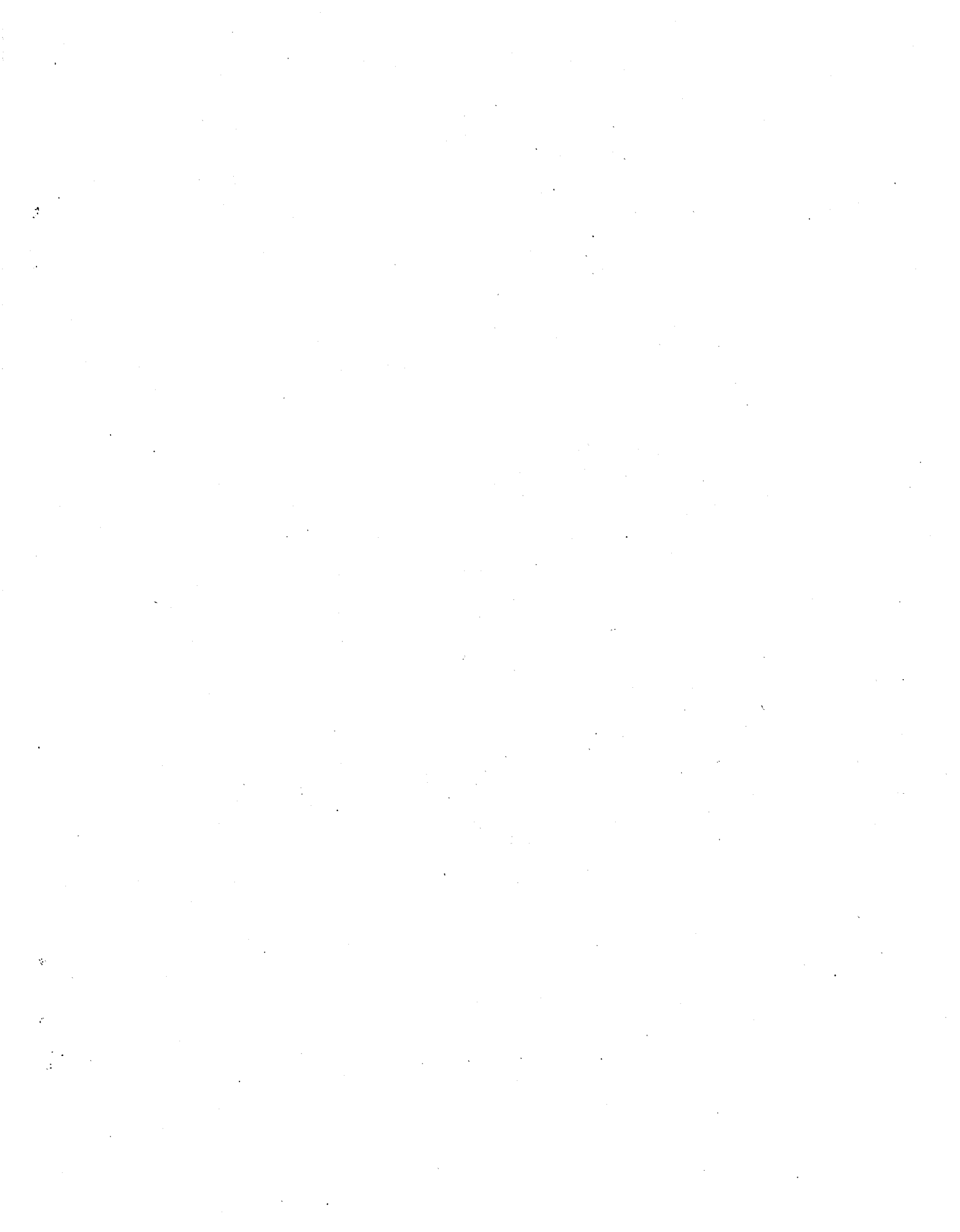

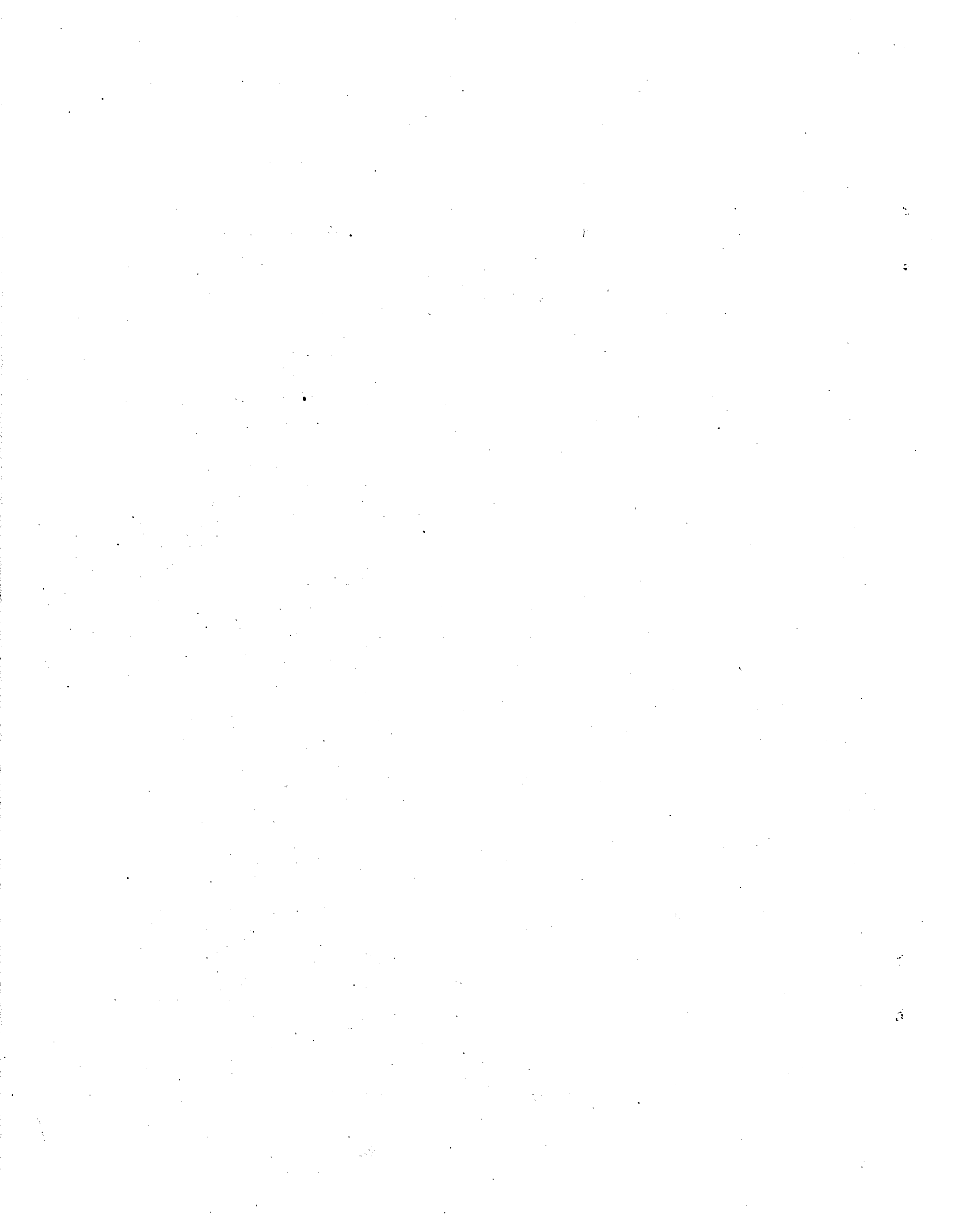

BLITZ KIT

**SECTION
THREE**

WIRING

Warning

Failure to reconnect all ground wires or replace metal shields and covers with each mounting screw installed and securely tightened may result in radio frequency interference.

JAMMA Chart

FUNCTION	WIRE COLOR	PIN	PIN	WIRE COLOR	FUNCTION
Ground	Black	A	1	Black	Ground
Ground	Black	B	2	Black	Ground
+5VDC	Red	C	3	Red	+5VDC
+5VDC	Red	D	4	Red	+5VDC
-5VDC	Yellow <i>B-Y</i>	E	5	Yellow <i>B/W</i>	-5VDC
+12VDC	Orange	F	6	Orange	+12VDC
Key	N/C	H	7	N/C	Key
Coin Counter 2	Brown-Red	J	8	Brown	Coin Counter 1
Not Used	N/C	K	9	N/C	Not Used
Speaker -, Left	Brown-Gray	L	10	Red-Gray	Speaker +, Left
Speaker -, Right	Brown-White	M	11	Red-White	Speaker +, Right
Video Green	Green	N	12	Red	Video Red
Video Sync	White	P	13	Brown	Video Blue
Service Credits	White-Gray	R	14	Shield	Video Ground
Slam Tilt	Black-Green	S	15	Black-Blue	Test
Coin 2	Black-Red	T	16	Black-Brown	Coin 1
2 Start	Violet-White	U	17	White	1 Start
Not Used	N/C	V	18	N/C	Not Used
Not Used	N/C	W	19	N/C	Not Used
Not Used	N/C	X	20	N/C	Not Used
Not Used	N/C	Y	21	N/C	Not Used
2 Jump/Tackle	Violet-Yellow	Z	22	White-Yellow	1 Jump/Tackle
2 Pass/Change	Violet-Green	a	23	White-Green	1 Pass/Change
2 Turbo	Violet-Blue <i>P/Y</i>	b	24	White-Blue <i>P/W</i>	1 Turbo
Not Used	N/C	c	25	N/C	Not Used
Not Used	N/C	d	26	N/C	Not Used
-5V Ground	Yellow-Brown	e	27	N/C	Not Used
Ground	Black	f	28	Black	Ground
SOLDER SIDE OF BOARD			COMPONENT SIDE OF BOARD		

Control Panel wires not part of the Main JAMMA Harness (49-way Joystick Cables)

2 Digital Ground	Black	1	1	Black	1 Digital Ground
Not Used	N/C	2	2	N/C	Not Used
Not Used	N/C	3	3	N/C	Not Used
Key	N/C	4	4	N/C	Key
Not Used	N/C	5	5	N/C	Not Used
Not Used	N/C	6	6	N/C	Not Used
2 U/D Bit 0	Grey-Black	7	7	Blue-Black	1 U/D Bit 0
2 U/D Bit 1	Grey-Brown	8	8	Blue-Brown	1 U/D Bit 1
2 U/D Bit 2	Grey-Red	9	9	Blue-Red	1 U/D Bit 2
2 U/D Dir Bit	Grey-Orange	10	10	Blue-Orange	1 U/D Dir Bit
2 L/R Bit 0	Grey-Yellow	11	11	Blue-Yellow	1 L/R Bit 0
2 L/R Bit 1	Grey-Green	12	12	Blue-Green	1 L/R Bit 1
2 L/R Bit 2	Grey-Blue	13	13	Blue	1 L/R Bit 2
2 L/R Dir Bit	Grey-Violet	14	14	Blue-Violet	1 L/R Dir Bit
Not Used	N/C	15	15	N/C	Not Used
PLAYER 4 INPUT/OUTPUT (Connector P10)			PLAYER 3 INPUT/OUTPUT (Connector P9)		

D.C. Power Source Voltage Limits

FUNCTION	RANGE LIMITS	ID	ID	RANGE LIMITS	FUNCTION
Digital Circuits	+4.90V to +5.10V	+5V	-5V	-4.75V to -5.25V	Audio, Lights
Audio, Disk Drive, DBV	+11.5V to +12.5V	+12V	NOTE: +5V is adjustable at the Power Supply		

CONTROL WIRING DIAGRAM (49-WAY JOYSTICK)

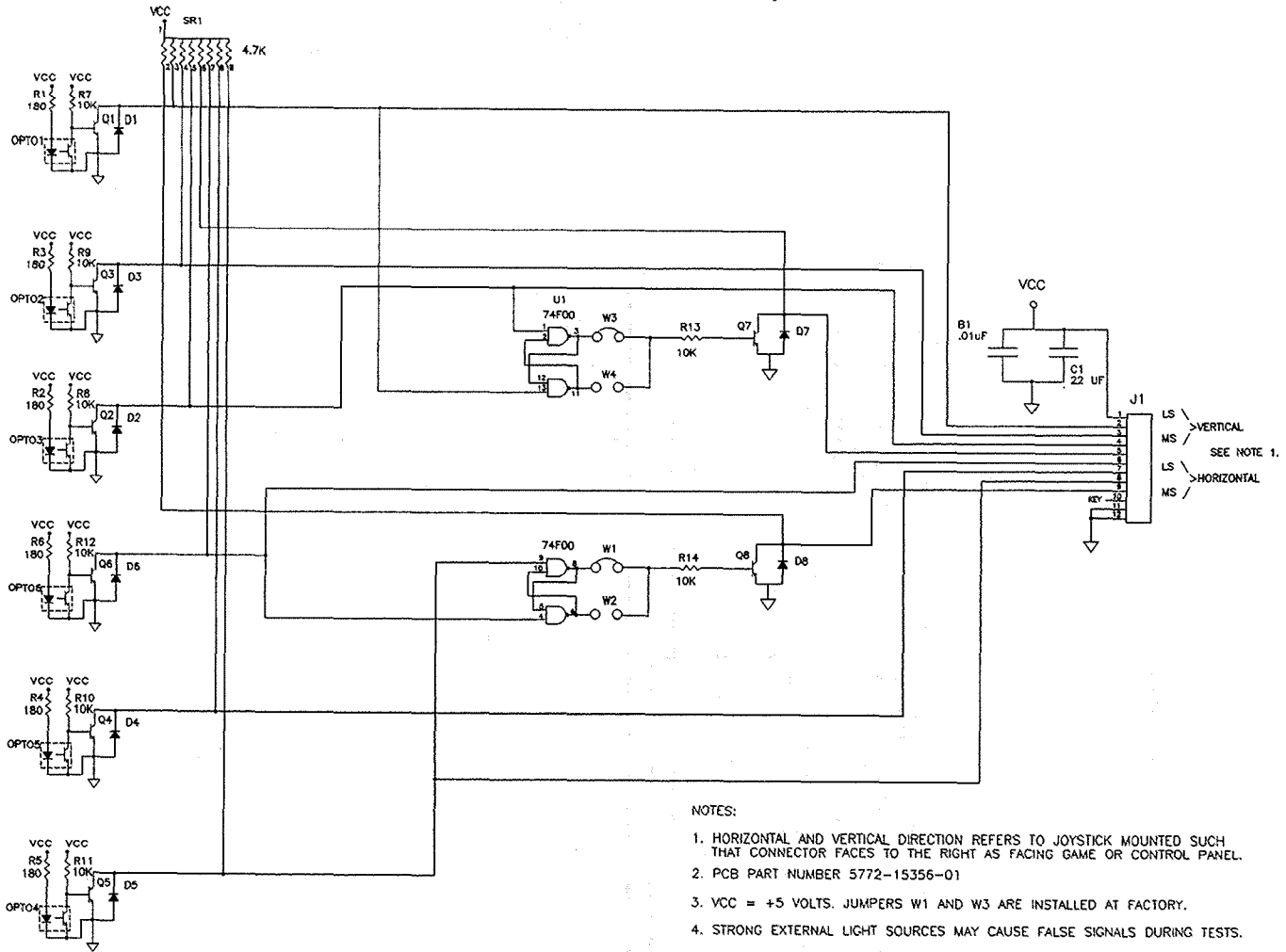

POSITION LOGIC TABLE

DIRECTION	FULLY LEFT	MODERATELY LEFT	SLIGHTLY LEFT	DEAD CENTER	SLIGHTLY RIGHT	MODERATELY RIGHT	FULLY RIGHT
FULLY UP	01110111 (00)	01110011 (01)	01110001 (02)	01110000 (03)	01111100 (04)	01111110 (05)	01111111 (06)
MODERATELY UP	00110111 (07)	00110011 (08)	00110001 (09)	00110000 (10)	00111100 (11)	00111110 (12)	00111111 (13)
SLIGHTLY UP	00010111 (14)	00010011 (15)	00010001 (24)	00010000 (24)	00011100 (24)	00011110 (19)	00011111 (20)
DEAD CENTER	00000111 (21)	00000011 (22)	00000001 (24)	00000000 (24)	00001100 (24)	00001110 (26)	00001111 (27)
SLIGHTLY DOWN	11000111 (28)	11000011 (29)	11000001 (24)	11000000 (24)	11001100 (24)	11001110 (33)	11001111 (34)
MODERATELY DOWN	11100111 (35)	11100011 (36)	11100001 (37)	11100000 (38)	11101100 (39)	11101110 (40)	11101111 (41)
FULLY DOWN	11110111 (42)	11110011 (43)	11110001 (44)	11110000 (45)	11111100 (46)	11111110 (47)	11111111 (48)

NOTE: 1. Connector pin sequence for the above data is as follows: 9 8 7 6 5 4 3 2 referred to ground at pin 12.
 2. Numbers in parentheses are found in the Switch Test. Program does not use the "slightly" positions.

CPU BOARD INDICATOR AND SWITCH LOCATIONS

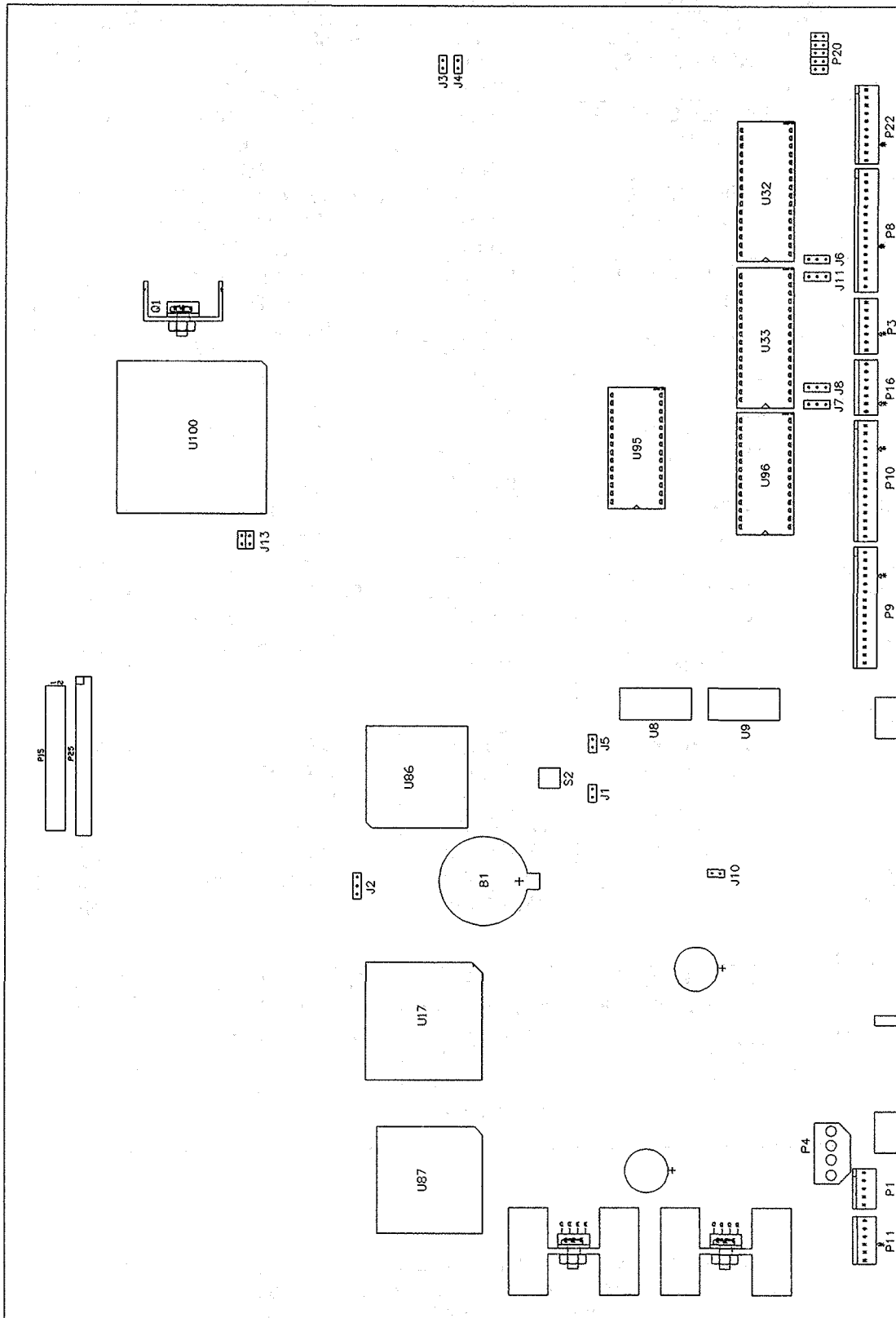

CPU BOARD JUMPER STATUS CHART

DESIGNATION	LOCATION	FUNCTION	MEANING	SETTING	DEFAULT
J1 (NOTE 1)	MIDDLE CENTER NEAR B1 & S2	REMOTE GAME RESET	RESERVED FOR FUTURE DEVELOPMENT	OPEN	■
				1 & 2	
J2 (NOTE 1)	MIDDLE CENTER NEAR B1 & U86	FUTURE USE ONLY	RESERVED FOR FUTURE DEVELOPMENT	OPEN	■
				1 & 2	
J3 (NOTE 2)	LEFT CENTER NEAR C1 & C589	WATCHDOG CIRCUIT ENABLE	FACTORY DEFAULT SOFTWARE FAIL SAFEGUARD	OPEN	■
				1 & 2	
J4 (NOTE 1)	LEFT CENTER NEAR C11 & C240	FUTURE USE ONLY	RESERVED FOR FUTURE DEVELOPMENT	OPEN	■
				1 & 2	
J5 (NOTE 1)	MIDDLE CENTER NEAR D6 & U64	FUTURE USE ONLY	RESERVED FOR FUTURE DEVELOPMENT	OPEN	■
				1 & 2	
J6 (NOTE 3)	UPPER LEFT NEAR P8 & U32	MAIN BOOT ROM SIZE AND TYPE	CONFIGURES U32 FOR 4 MEGABYTE BOOT ROM	OPEN	■
				1 & 2	
J7 (NOTE 3)	UPPER LEFT NEAR P10 & U33	MAIN BOOT ROM SIZE AND TYPE	CONFIGURES U32 FOR 4 MEGABYTE BOOT ROM	OPEN	■
				1 & 2	
J8 (NOTE 3)	UPPER LEFT NEAR P16 & U33	MAIN BOOT ROM SIZE AND TYPE	CONFIGURES U32 FOR 4 MEGABYTE BOOT ROM	OPEN	■
				1 & 2	
J9 (NOTE 4)	NONE	NOT USED	NONE	NONE	---
J10 (NOTE 5)	UPPER RIGHT NEAR C640 & U14	VIDEO SYNC SIGNAL	NEGATIVE VIDEO SYNC POLARITY	OPEN	■
				1 & 2	
J11 (NOTE 3)	UPPER LEFT NEAR P3 & U33	EXPANSION ROM SIZE AND TYPE	RESERVED FOR FUTURE DEVELOPMENT	OPEN	■
				1 & 2	
J12 (NOTE 4)	NONE	NOT USED	NONE	NONE	---
J13 (NOTE 1)	LOWER LEFT NEAR U25 & U100	JTAG PROCESSOR FEATURES	RESERVED FOR FUTURE DEVELOPMENT	OPEN	■
				1 & 2	
P20	UPPER LEFT NEAR P22 & U32	CPU BOARD PRODUCTION TEST JACK	USED FOR FACTORY TEST ONLY	DO NOT USE JUMPER S	---

NOTES:

1. Jumper is not required for any version of this CPU Board. Connections are made with copper on board.
2. Jumper is not required for versions 01-05 of this CPU Board. Jump pins 1 & 2 for version 06 and up.
3. Jumper changes for some sizes and types of ROM. Jumper positions shown in ROM kit instructions.
4. Jumper is not required for any version of this CPU Board. These pins are not present on CPU Board.
5. Jumper is not required for production video monitors. Jump pins 1 & 2 for positive sync type monitors.

CPU SWITCHES

DESIGNATION	LOCATION	FUNCTION	POSITIONS	STATE	MEANING
S2	MIDDLE CENTER NEAR U41 & B1	WARM START RESET	1	OFF	NORMAL OPERATION
				ON	FORCED CPU RESET
U8	MIDDLE CENTER NEAR U20 & U94	SOFTWARE GAME MODES	8	OFF	STANDARD SETTINGS
				ON	CUSTOM SETTINGS
U9	MIDDLE CENTER NEAR U20 & U94	SOFTWARE GAME MODES	8	OFF	STANDARD SETTINGS
				ON	CUSTOM SETTINGS

CPU BOARD LED INDICATOR STATUS CHART

DESIGNATION	LOCATION	FUNCTION	COLOR	STATE	MEANING
LED 1 (HDD)	BOTTOM CENTER NEAR P15 & P25	HARD DISK ACTIVITY	RED	OFF	NOT IN USE
				ON	LOCKED UP (Note 1)
				BLINKING	NORMAL OPERATION
LED 2	MIDDLE CENTER NEAR B1 & S2	CPU RESET INDICATOR	RED	OFF	NORMAL OPERATION
				ON	PROCESSOR RESET
				BLINKING	RESET LOOP (NOTE 2)
LED 3	MIDDLE CENTER NEAR B1 & S2	INDICATOR	YELLOW	OFF	NORMAL OPERATION
				ON	PROCESSOR RESET
				BLINKING	RESET LOOP (NOTE 3)

NOTES:

1. Hard Disk Drive LED 1 only active in short bursts during game. May appear continuous during start up. If this LED is always on, there may be a fault that has caused the drive to be in a locked up condition.
2. LED 2 monitors a part of the ROM boot instruction set. Must be active only during power on or reset.
3. LED 3 monitors a part of the ROM boot instruction set. Must be active only during power on or reset.

CPU BOARD LED INDICATOR STATUS CHART (continued)

DESIGNATION	LOCATION	FUNCTION	COLOR	STATE	MEANING
LED 4	MIDDLE CENTER NEAR B1 & S2	INDICATOR	GREEN	OFF	NO BOOT ROM (NOTE 4)
				ON	PROCESSOR RESET
				BLINKING	NORMAL OPERATION
LED 5 (IOA)	UPPER CENTER NEAR U8 & U9	CONTROL ACTIVITY	GREEN	OFF	NO I/O FUNCTIONS PRESENT
				ON	NORMAL OPERATION
				BLINKING	I/O ASIC FAULT (NOTE 5)
LED 6 (SND)	UPPER LEFT NEAR U95 & U101	SOUND ACTIVITY	YELLOW	OFF	NO AUDIO ROM (NOTE 6)
				ON	READING ROM INSTRUCTIONS
				BLINKING	NORMAL OPERATION
LED 7 (+12V)	UPPER RIGHT NEAR C409 & L1	+12V POWER INDICATOR	RED	OFF	NO POWER
				ON	NORMAL OPERATION
				BLINKING	POWER FAULT (Note 7)
LED 8 (-5V)	UPPER RIGHT NEAR L2 & P4	-5V POWER INDICATOR	RED	OFF	NO POWER
				ON	NORMAL OPERATION
				BLINKING	POWER FAULT (Note 8)
LED 9 (+5V)	UPPER RIGHT NEAR P14 & R571	+5V POWER INDICATOR	RED	OFF	NO POWER
				ON	NORMAL OPERATION
				BLINKING	POWER FAULT (Note 9)

NOTES:

4. Boot ROM is only active in short bursts during start up. May appear very irregular during circuit reset.
5. I/O ASIC is only active in short bursts during start up. Must be on continuously during game play.
6. Sound is only active in short bursts during start up. Must be on continuously during game play.
7. LED 7 monitors a regulated power supply voltage source. Must be on continuously at all times.
8. LED 8 monitors a regulated power supply voltage source. Must be on continuously at all times.
9. LED 9 monitors a regulated power supply voltage source. Must be on continuously at all times.

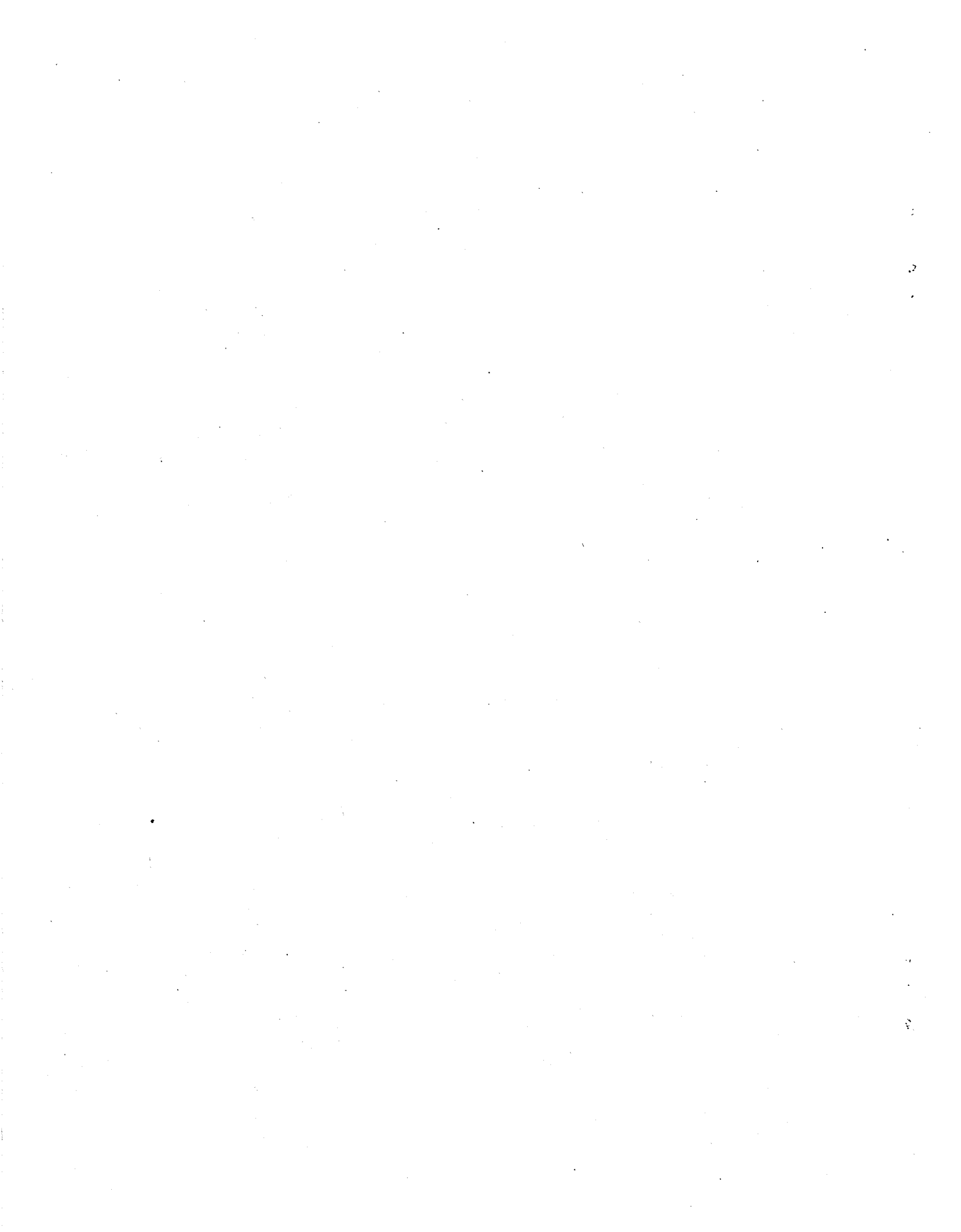

BLITZ KIT

SECTION FOUR

TROUBLESHOOTING

This game uses complex electronic components that are very SENSITIVE to static electricity. The following precautions must be observed and followed prior to handling any of the game electronics.

1. Ensure that the A.C. power to the game is turned OFF prior to servicing the electronics.
2. Discharge any static electricity build up in your body by touching the safety ground stud of the power supply chassis while the line cord is connected to a properly grounded outlet. This is to be done BEFORE touching or handling the electronic assemblies.
3. Store the electronic assemblies in an anti-static area. Anti-static bags are to be used to store or transport the game CPU Board Assembly.
4. DO NOT remove or connect any electronic assemblies when the cabinet power is ON. Doing so will damage the electronic assemblies and void the warranty.
5. Always replace ground wires, shields, safety covers, etc. when maintenance or service is completed. Ensure that all ground and mounting screws are installed and tightened firmly.

GAME DOES NOT START

1. Game appears completely non-functional; no audio, no illumination, no video display.

- A: Check that the Power Switch has been turned ON (top left rear corner of the typical cabinet).
- B: Turn OFF the game power. Unplug the A.C. line cord. Unlock and remove the cabinet rear door. The Power Supply Line Voltage Switch must be set to agree with the local A.C. line voltage.
- C: Remove the Line Cord Cover Plate. Test the line cord, power plug and I.E.C. connector for breaks or damage. Verify the continuity of each wire in the cord. Fully seat the I.E.C. connector into the mating receptacle of the cabinet. Replace the cover plate and all four screws.
- D: Ensure that cabinet wiring harness connectors are fully seated in the corresponding A.C. Power Chassis Assembly connectors (refer to Power Wiring Diagram, Section Three).
- E: Examine the A.C. Line Fuse on the A.C. Power Chassis. If the fuse is faulty, replace it with an identical fuse from the spare parts bag. Replace the spare fuse when repairs are complete.
- F: Fully seat the A.C. plug in the outlet. Verify that A.C. line voltage is present. Turn the game power ON. Check the D.C. wiring harness and connectors if the fuse opens the circuit again.

2: Video game appears non-functional, but currency acceptor price indicator is illuminated.

- A: Unlock and open the coin door. Inspect the CPU Board Assembly under low light level conditions. A glow will be seen from the Light Emitting Diodes if there is voltage in the processor circuits. This does not mean that voltages or signals are as they should be, but it does indicate that the CPU Board is receiving some D.C. power from the Power Supply.
- B: Turn OFF the game power. Unlock, open and remove the rear door. Remove cover and inspect the CPU Board Assembly. Ensure that the JAMMA Wire Harness connector is attached and fully seated onto mating board connector. Check the other wiring harness connectors in the same way.

CAUTION: DO NOT REMOVE OR INSTALL ANY CONNECTOR WHEN POWER IS TURNED ON. DOING SO WILL DAMAGE THE CPU BOARD OR HARD DISK DRIVE AND VOID THE WARRANTY.

- C: Verify that the game CPU DIP Switches are set as intended. Refer to the DIP-Switch Test (Section Two) for variables and default settings. *Incorrect settings will affect other test results.*
- D: Turn ON the game power. Using the 20 Volt D.C. setting on a digital voltmeter, measure D.C. voltages present at the Power connector pins. Adjust the +5V source if it is necessary. Refer to the Cabinet Wiring Diagram (Section Three) for specific wiring information and voltage limits.
- E: Using the 2 Volt A.C. setting on a digital voltmeter, measure the same D.C. voltages as above. Any reading here indicates that the supply voltages are unstable and may contain ripple or noise.
- F: Verify that the game runs and completes the power-up self-test sequence without any errors. Note errors and/or failures found during these tests.
- G: Enter the game Menu System by pressing and holding the BEGIN TEST switch inside the coin door. Select DIAGNOSTICS from the Main menu. Once in the DIAGNOSTICS menu, choose MONITOR SETUP (refer to Section Two for additional details). Use this set of tests to check the operation of each screen used in the game.

GAME CAN NOT BE PLAYED

1. Game will not accept currency or tokens and cannot be started. Audio and video are present.

- A: Unlock and open the cash door. Empty the cash box. Inspect the revenue for any counterfeit currency. Check the vault and remove any items that block the path from the mechanism.
- B: Unlock and open the coin door. Check each Acceptor by hand to ensure proper mounting. Remove the mechanism and clear the currency path. Reinstall the mechanism and latch it.
- C: Verify that the mechanism is level when the doors are closed. Repair or replace the coin door if it is bent or damaged. Adjust the cabinet leg levelers if necessary to keep mechanisms vertical.

2. Game accepts currency or tokens, but does not start. Audio and video are present.

- A: Unlock and open the coin door. Check each Acceptor by hand to ensure proper mounting. Verify that each of the release latches is in the closed and locked position. Test known good and bad coins to see if the mechanism accepts and rejects the currency correctly.
- B: Ensure that no loose parts or wires are caught in the hinges, latches, or switch contacts.
- C: Inspect to see if the external Acceptor indicators (Pricing, Flashing Arrows, etc.) are illuminated. Check connectors and cables for wiring continuity from CPU Board connectors to the Acceptors.
- D: Enter the game Menu System by pressing and holding the BEGIN TEST switch inside the coin door. From the DIAGNOSTICS menu, choose the SWITCH TESTS (refer to Section Two for additional details). Use these tests to confirm the operation of each switch used in the game.
- E: Check for continuity in each of the suspect switch connections (Common to Normally Open or Common to Normally Closed). Replace faulty switches (bent levers, broken actuators, etc.).
- F: Verify that each Acceptor is operating properly by placing it in a known good unit.

3. Player controls are intermittent or completely non-functional. Game starts normally.

- A: Unlock and open the coin door. Enter the game Menu System by pressing and holding the BEGIN TEST switch inside the coin door. From the DIAGNOSTICS menu, choose the SWITCH TESTS (refer to Section One for additional details). Use these tests to confirm the operation of each switch used in the game.
- B: Verify that the game CPU DIP Switches are set as intended. Refer to the DIP-Switch Test (Section Two) for variables and default settings. Incorrect settings will affect other test results. Ensure that the correct joystick type is selected (Switch U8-1).
- C: Reach through the coin door and unlatch the control panel. Grip the joysticks and carefully tilt the panel back on its hinge. Ensure that no loose parts or wires are caught in the hinges, latches, or switch contacts. Verify that the harness connectors are attached and fully seated.
- D: Check that the cabinet wiring is correct for this game. Ensure that the control switches are properly connected to the control input wires from P3, P9, P10, P16, and the JAMMA connector. Refer to the Cabinet Wiring Diagram (Section Three) for specific wiring information.
- E: Verify continuity in each of the switch connections (Common to Normally Open or Common to Normally Closed). Ensure that the control is operating properly by placing in a known good unit.

4. Game accepts currency or tokens, but number of credits per coin or bill is incorrect.

- A: Unlock and open the coin door. Enter the game Menu System by pressing and holding the BEGIN TEST switch inside the coin door. From the DIAGNOSTICS menu, choose the SWITCH TESTS (refer to Section Two for additional details). Use these tests to confirm the operation of each switch used in the game.
- B: From the ADJUSTMENTS menu, choose PRICING to verify units and credits are set correctly.
- C: Check that the cabinet wiring is correct for this game. Ensure that the coin meter and coin switches are properly connected to the control input wires from the JAMMA connector and other CPU wiring. Refer to the Cabinet Wiring Diagram (Section Three) for specific wiring information.

COIN SWITCH AND METER WIRING

FACTORY STANDARD

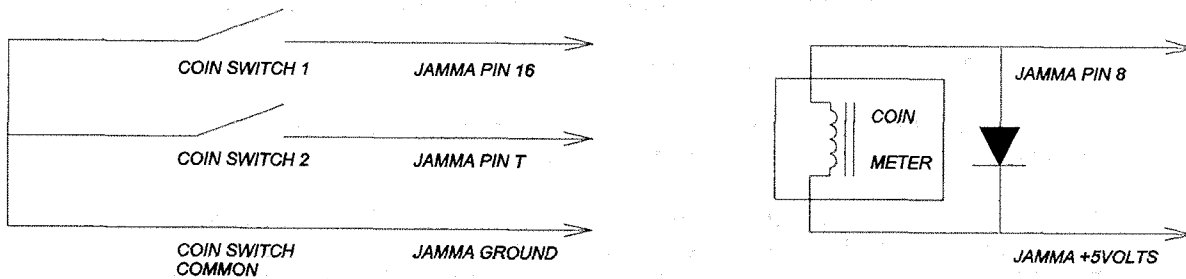

OPTIONAL WIRING

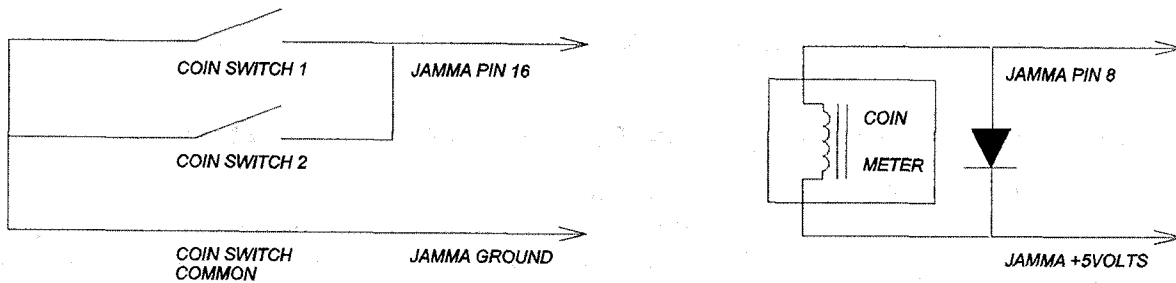

INCORRECT WIRING

A connection between JAMMA coin input pins will cause twice the desired credits for each coin inserted. A coin meter with a defective or missing diode may eventually damage driver circuits on the CPU Board.

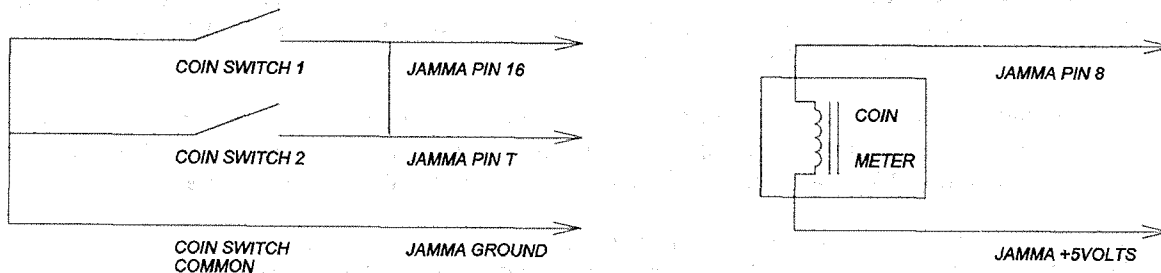

JOYSTICK DIFFICULTIES

1: Players complain about joystick motion, but game appears to operate normally.

- A: Ensure that control panel hole size is adequate for 49-way joysticks. This joystick has a greater range of motion than standard joysticks, requiring a larger clearance opening in the panel (1.50 in. 38 mm). A smaller hole may prevent activation of the outer control bits, limiting character speed.
- B: Verify that the joystick is exactly centered under the control panel hole. Slight misalignment may cause a loss of full character speed in only one direction. This difficulty can be detected by entering the menu system from the BEGIN TEST switch inside the coin door. From the DIAGNOSTICS menu, choose the SWITCH TESTS (refer to Section Two for additional details).
- C: Sticking can result if liquids are spilled onto the control panel. Disconnect the cable from the joystick in question and remove the four philips head screws at the corners of the slide retainer. Lift the slide retainer off of the joystick base. Clean but do not lubricate the sliding pieces.
- D: Sloppy action or weak return pressure may be related to the joystick centering grommet. Turn OFF the game power and open up the control panel. Disconnect and disassemble as described above. Lift the slide retainer and electronics off of the joystick base. Examine the grommet and spacer for wear or damage and replace as required. Clean the components before reassembly.

2: Joystick operation is inconsistent during game play.

- A: 49-way joysticks use optical position sensors. Inspect interior of control area for sources of light that could shine on the joystick electronics and cause false signals. Cover or shield lighting as needed to eliminate high levels of illumination near the joysticks.
- B: Turn ON the game power. Using the 20 Volt D.C. setting on a digital voltmeter, measure D.C. voltages present at the joystick connector pins. Verify the +5V and ground connections. Refer to the Cabinet Wiring Diagram (Section Three) for specific wiring information and voltage limits.
- C: Using the 2 Volt A.C. setting on a digital voltmeter, measure the same D.C. voltages as above. Any reading here indicates that the supply voltages are unstable and may contain ripple or noise.
- D: Turn OFF power and interchange joystick connectors to determine if problem is in a cable.
- E: Verify proper operation of 49-way Joystick Assembly by placing it in a known good game.

AUDIO PROBLEMS

1: Audio is non-functional, but video is present and game appears to operate normally.

- A: Unlock and open the coin door. Enter the game Menu System by pressing and holding the BEGIN TEST switch inside the coin door. From the Main menu, choose VOLUME LEVEL (refer to Section Two for additional details). Verify that the volume levels have not been set at Zero. Change the levels if necessary to make the game audible.
- B: From the ADJUSTMENTS menu, choose ATTRACT SOUND to see if this feature is active (ON).
- C: Follow the on-screen instructions to return to the first menu. Select DIAGNOSTICS from the Main menu. Once in the DIAGNOSTICS menu, choose SOUND SUBSYSTEM. These tests will confirm the operation of each segment of the sound system.
- D: Turn OFF the game power. Open the marquee and remove the glass. Inspect the speakers and harness. Ensure that no loose parts or wires are caught in speaker cones, terminals, mounting screws, or stuck to the magnets.
- E: Verify correct cabinet wiring for this game. Ensure that the speakers are properly connected to the audio output wires from the JAMMA connector. Verify speaker and wire harness continuity. Refer to the Cabinet Wiring Diagram (Section Three) for specific wiring information.
- F: Turn ON the game power. Using the 20 Volt D.C. setting on a digital voltmeter, measure D.C. voltages present at the Power connector pins. Verify the +5V, -5V and +12V sources. Refer to the Cabinet Wiring Diagram (Section Three) for specific wiring information and voltage limits.
- G: Using the 2 Volt A.C. setting on a digital voltmeter, measure the same D.C. voltages as above. Any reading here indicates that the supply voltages are unstable and may contain ripple or noise.
- H: Verify proper operation of game CPU Board Assembly by placing it in a known good game.

2: The audio is distorted, muffled or missing frequencies. A constant low hum may be present.

- A: Unlock and open the coin door. Enter the game Menu System by pressing and holding the BEGIN TEST switch inside the coin door. From the Main menu, choose DIAGNOSTICS from the Main menu. Once in the DIAGNOSTICS menu, choose SOUND SUBSYSTEM. These tests will confirm the operation of each segment of the sound system.
- B: Turn OFF the game power. Open the marquee and check the speakers. This game uses coaxial speakers, not discrete woofer and tweeter units. Ensure that each speaker is FULL RANGE (100 to 10,000 Hz response) and rated for at least 25 WATTS.
- C: Check that the speaker wiring is not reversed at one of the speakers. Weak low frequencies and a thin or hollow sound quality is a symptom of incorrectly phased speakers. This condition may not be detected by the SOUND SUBSYSTEM, but it will be audible during normal game operation.
- D: Check that the cabinet wiring is correct for this game. Verify that the cabinet wiring provides separate wires (not a common return) for each speaker. Ensure that all cabinet ground wires are connected. Refer to the Cabinet Wiring Diagram (Section Three) for specific wiring information.
- E: Using the 2 Volt A.C. setting on a digital voltmeter, measure voltages at the speaker terminals. Any reading here indicates that the supply voltages are unstable and may contain ripple or noise.
- F: Verify that the speaker is operating properly by placing in a known good unit.

VIDEO PROBLEMS

1. Monitor appears non-functional, but audio is present and controls operate as expected.

- A: Unlock and open the rear door. Verify that A.C. Power is connected to the Video Monitor. Inspect the neck of the CRT under low light level conditions. A glow will be seen near the CRT base if there is voltage in the filament circuits. This does not mean that other voltages or signals are as they should be, but it does indicate that some of the monitor circuits are receiving power.
- B: Turn OFF the game power. Verify that the Video Signal and the Remote Adjustment Board connectors are fully seated on the Video Monitor Board Assembly. Check the other monitor connectors in the same way. **Do not operate a monitor without a Remote Adjustment Board.**
- C: Examine the A.C. line fuse on the Video Monitor Board Assembly. If the fuse is faulty, replace it with an identical fuse of the proper voltage and current rating.
- D: Ensure that no loose parts or wires are caught on the chassis or the mounting brackets.
- E: Check that the brightness (intensity) and contrast have not been set to their minimum levels.
- F: Verify that the Video Monitor is operating correctly by placing it in a known good unit.

2: The power-up self-test will run, but the game does not appear. No audio is present.

- A: Note and record any error messages that occur during self-test. Open the coin door. Press and hold the BEGIN TEST switch to enter the menu system. Select DIAGNOSTICS from the Main menu. Once in the DIAGNOSTICS menu, choose DISK TESTS (refer to Section One for additional details). Use this set of tests to check the operation of critical components.
- B: Turn OFF the game power. Unlock and remove the rear door. Inspect the CPU Board Assembly. Ensure that the JAMMA cable connector is fully seated into the mating edge connector on the CPU Board. Check the other cable connectors for correct alignment and continuity.

CAUTION: DO NOT REMOVE OR INSTALL ANY CONNECTOR WHEN POWER IS TURNED ON. THIS WILL DAMAGE THE CPU BOARD OR HARD DISK DRIVE AND VOID THE WARRANTY.

- C: Verify that the ROM instruction set is correct for this game. There is more than one ROM in a game set. Each ROM circuit is labeled with the assembly number and the software version.
- D: Verify that the CPU Board Assembly is correct for this game. Each CPU Board is marked with the manufacturer name, assembly number and the hardware version.
- E: Verify that the Hard Disk Drive Assembly is correct for this game. Each Hard Disk Drive unit is marked with the manufacturer name, assembly number and the program version.
- F: Turn ON the game power. Using the 20 Volt D.C. setting on a digital voltmeter, measure D.C. voltages present at the Power connector pins. Verify the +5V source if it is adjustable. Refer to the Cabinet Wiring Diagram (Section Three) for specific wiring information and voltage limits.
- G: Using the 2 Volt A.C. setting on a digital voltmeter, measure the same D.C. voltages as above. Any reading indicates that the supply voltages are unstable and may contain ripple or noise.
- H: Compare CPU Board jumper positions with the CPU Jumper Status Chart (Section Three).
- I: Compare CPU Board Light Emitting Diode states with the CPU Indicator Chart (Section Three).

3. Monitor will not lock onto the signal and provide a stable picture, colors are missing, etc.

- A: Unlock and open the coin door. Enter the game Menu System by pressing and holding the BEGIN TEST switch inside the coin door. From the DIAGNOSTICS menu, choose DIP-SWITCH TESTS (refer to Section Two for additional details). Verify that the GRAPHICS MODE is correct.
- B: Check connectors and cables for wiring continuity from the CPU Board to the Video Monitor.
- C: Ensure that the Video Monitor Assembly is correct for this game. Use of video monitors with different resolution will result in what appears to be horizontal tearing or complete loss of sync.
- D: Verify that the Video Monitor is operating correctly by placing it in a known good unit.

4: Game operates normally, but video picture wavers or rolls, has dark bars, uneven colors, etc.

- A: Check connectors and cables for wiring continuity from the CPU Board to the Video Monitor.
- B: Ensure that all the cabinet ground wires are connected, especially at the Video Monitor Chassis.
- C: Move the cabinet farther away from machines, appliances, other games, etc. Very strong electrical or magnetic fields are emitted from some equipment when it is operating normally.
- D: Verify that the Video Monitor is operating correctly by placing it in a known good unit.

MISCELLANEOUS

1: Marquee lamp is intermittent or non-functional. Game starts and plays normally.

- A: Open the marquee and remove the glass. Remove the plastic lamp locks and the fluorescent tube from the holders. Install a new lamp if cracks or darkened ends are found. Clean the tube.
- B: Verify that the lamp and starter pins are making good connection with their socket contacts.
- C: Measure the Fluorescent Lamp Assembly A.C. voltages (Power Wiring Diagram, Section Three). Check wiring and connector continuity from the A.C. Power Chassis to the Lamp Assembly.
- D: Ensure that the Fluorescent Lamp Ballast is rated for the local A.C. line voltage and frequency.
- E: Check for continuity of both fluorescent lamp filaments, the starter, and the ballast. One at a time, verify that the lamp, starter, and ballast operate by placing each in a known good unit.

2. Game operates normally, but cabinet gets very warm after several hours of use.

- A: Check bottom and rear of cabinet for blocked air flow. Move game away from sources of heat.
- B: Turn OFF the game power. Apply high power vacuum cleaner to vent holes to remove dust.
- C: Unlock and remove the rear door. Ensure that all fans are connected and operating.

3. Error Messages appear on the screen. The game does not start and there is no audio.

- A: Check any assembly (RAM, ROM, Battery, etc.) identified in the Error Message.
- B: Call your authorized distributor for help with unresolved screen messages.

NOTES

C

4

1

C

4

2

C

WARNINGS & NOTICES

WARNING

USE OF NON-MIDWAY PARTS OR CIRCUIT MODIFICATIONS MAY CAUSE SERIOUS INJURY OR EQUIPMENT DAMAGE! USE ONLY MIDWAY AUTHORIZED PARTS.

- * For safety and reliability, substitute parts and modifications are not recommended.
- * Use only authorized components and parts. Failure to do so will void warranty and may result in incorrect and/or unsafe operation. Substitute parts or modifications may void FCC type acceptance.
- * This game is protected by federal copyright, trademark and patent laws. Unauthorized modifications may be illegal under federal law. This also applies to MIDWAY logos, designs, publications and assemblies. Moreover, facsimiles of MIDWAY equipment (or any feature thereof) may be illegal under federal law, regardless of whether or not such facsimiles are manufactured with MIDWAY components.

WARNING

Prevent shock hazard and assure proper game operation. Only plug this game into a properly grounded outlet. Do not use a cheater plug to defeat the power cord's grounding pin. Do not cut off the ground pin.

WARNING

A very small portion of the population has a condition which may cause them to experience epileptic seizures or have momentary loss of consciousness when viewing certain kinds of flashing lights or patterns that are present in our daily environment. These persons may experience seizures while watching some kinds of television pictures or playing certain video games. People who have not had any previous seizures may nonetheless have an undetected epileptic condition.

If you or anyone in your family has experienced symptoms linked to an epileptic condition (e.g. seizures or loss of awareness), immediately consult your physician before using any video games.

We recommend that parents observe their children while they play video games. If you or your child experience the following symptoms: dizziness, altered vision, eye or muscle twitching, involuntary movements, loss of awareness, disorientation, or convulsions, DISCONTINUE USE IMMEDIATELY and consult your physician.

NOTE: This equipment has been tested and found to comply with the limits for a Class A digital device, pursuant to Part 15 of the FCC Rules. These limits are designed to provide reasonable protection against harmful interference when the equipment is operated in a commercial environment. This equipment generated, uses and can radiate radio frequency energy and if not installed and used in accordance with the instruction manual, may cause harmful interference to radio communications. Operation of this equipment in a residential area is likely to cause harmful interference in which case the user will be required to correct the interference at his own expense.

NOTICE - FCC COMPLIANCE LABEL

- I. THIS KIT WAS TESTED IN A MIDWAY UNIVERSAL VIDEO CABINET (MODEL 40135) AND FOUND TO COMPLY WITH FCC PART 15 CLASS A REQUIREMENTS. IF INSTALLED IN A MIDWAY UNIVERSAL VIDEO CABINET (MODEL 40135), THE FCC COMPLIANCE LABEL SUPPLIED IS TO BE PLACED ON THE REAR OF THE CABINET.
- II. INSTALLATION OF THIS KIT INTO ANY OTHER PRODUCT DOES NOT GUARANTEE COMPLIANCE WITH FCC REQUIREMENTS. YOU ARE SOLELY RESPONSIBLE, AND MIDWAY WILL HAVE NO RESPONSIBILITY, FOR FCC COMPLIANCE FOR INSTALLATIONS IN OTHER PRODUCTS. THE FCC COMPLIANCE LABEL SUPPLIED SHOULD NOT BE INSTALLED ON THE CONVERTED PRODUCT UNTIL FCC COMPLIANCE IS VERIFIED.

NOTICE

No part of this publication may be reproduced by any mechanical, photographic, or electronic process, or in the form of a phonographic recording, nor may be transmitted, or otherwise copied for public or private use, without permission from the publisher.

©1997 Midway Games Inc. All rights reserved. MIDWAY® and BLITZ™ are trademarks of MIDWAY GAMES INC. ©1997 NFLP. Team names and logos are trademarks of the teams indicated. The NFL shield, Super Bowl, and Pro Bowl are trademarks of the National Football League. Officially Licensed Product of the National Football League Players.

For Service: Call your Authorized MIDWAY Distributor.

MIDWAY GAMES INC.
3401 N. CALIFORNIA AVE.
CHICAGO, ILLINOIS 60618